



Specification and Performance

Multi - Zone Systems

208V-230V 18k-36k

Ductless Mini Split:

- ◆ Heat Pump
- ◆ Multi-zone application flexibility with 85 different 2, 3, 4, 5 zone combinations.
- ◆ 21.5 to 22.5 SEER high efficiency models with capacities from 18,000 Btuh to 36,000 Btuh.
- ◆ Easy installation requiring no ductwork, a small hole for running power wiring and refrigerant lines is all that is needed to connect indoor and outdoor sections.
- ◆ Low profile indoor air handler is neutral color that blends with any decor. Choice of wall or ceiling cassette air handlers is available.
- ◆ Next generation outdoor condenser with inverter compressor provides exceptionally quiet operation and intelligently adjusts speed to temperature conditions.
- ◆ Low noise.
- ◆ Low operating cost.
- ◆ Optional Wall Thermostat.
- ◆ Simple design makes it easy to remove and clean the washable filters.
- ◆ Intelligent Design allows system to intelligently adjust the angle of the louver to ensure greatest efficiency for heating and cooling. For more control, manually adjust louver as small as 6 degrees using the hand-held remote.

Features:

- All models supplied with hand-held Infrared Remote Controller with easy-to-read LCD display. Factory installed operating features provide capacity to set temperature, louver control, fan speeds and more.
- Follow-Me Technology - Mode that activates a temperature sensor that is built into Infrared remote control. When you stay close to the remote control, the unit will continue to condition the space until you are comfortable.
- Turbo Mode - Air condition maximizes output of cooling and heating capacity, making the room cool down or heat up rapidly and attain the desired temperature in the shortest time.
- Auto Restart - If system shuts down due to power failure, system will restart with previous function setting when power is restored.
- Auto Level Swing Louvers - In cooling mode, louvers self adjust to horizontal position and circulate cold air more efficiently. In heating mode, louvers deflect hot air downward so hot air will rise and circulate keeping the room warm.
- 24 Hour Timer - Set a wide variety of timer based operations, start and stop at specific times. Control fan speed as well as cool, heat and auto from anywhere in the room.
- Sleep Mode - Enables the system to gradually decrease cooling or heating output automatically during night operation to maintain comfort level while saving energy.

Multi - Zone Systems

208V-230V 18-36k

Model Outdoor			MZ2H18D	MZ3H27D	MZ4H36D	MZ5H45DAA
Power Supply		V-Hz-Ph	208-230V-60Hz, 1Ph	208-230V-60Hz, 1Ph	208-230V-60Hz, 1Ph	208-230V-60Hz, 1Ph
Cooling	Nominal Capacity	Btu/h	17000	27000	36000	48000
	EER	Btu/w	12.5	12.0	10.9	11.6
	SEER	Btu/w	21.3	22.0	22.5	21.5
Heating	Capacity	Btu/h	18000	28000	36000	48000
	HSPF4	Btu/w	10.0	9.8	10.3	10.4
Low Temperature Capacity (5F)		Btu/h	14200	20900	28800	35800
Operating Temperature Range - Outdoor unit		Cooling	(-13F - 122F)	(-13F - 122F)	(-13F - 122F)	(-13F - 122F)
		Heating	(-13F-86F)	(-13F-86F)	(-13F-86F)	(-13F-86F)
Energy Star			Yes - Most Efficient	No	No	No
Outdoor Unit	Dimensions (W*D*H)	inches	33¼ x 14 5/16 x 27 5/8	37¼ x 16 1/8 x 31 7/8	37¼ x 16 1/8 x 31 7/8	37 ½ x 16 1/8 x 52 ½
	Dimensions (W*D*H)	mm	845 x 363 x 702	946 x 410 x 810	946 x 410 x 810	952 x 415 x 1333
Refrigerant Precharge		ft	25	25	25	25
Additional charge for each ft		oz	0.161	0.161	0.161	0.32
Design Pressure		PSIG	550/340 PSIG	550/340 PSIG	550/340 PSIG	550/340 PSIG
Refrigerant Piping	Liquid side/Gas side Flare nut with imperial threads	Inches (mm)	1/4" x 3/8" (6.35 x 9.52)	1/4" x 3/8" (6.35 x 9.52)	1/4" x 3/8" (6.35 x 9.52)	1/4" x 3/8" (6.35 x 9.52)
	Max. refrigerant pipe length - All indoor units	Feet (meters)	98 (30)	148 (45)	197 (60)	246 (75)
	Max. refrigerant pipe length - One indoor unit	Feet (meters)	66 (20)	82 (25)	98 (30)	98 (30)
	Max difference between OD higher than indoor	Feet (meters)	33 (10)	33 (10)	33 (10)	33 (10)
	Max difference between OD lower than indoor	Feet (meters)	49 (15)	49 (15)	49 (15)	49 (15)
Minimum Circuit Ampacity		Amps	15	19	27	35
Max Fuse Size		Amps	20	25	40	50

MZ1H18D

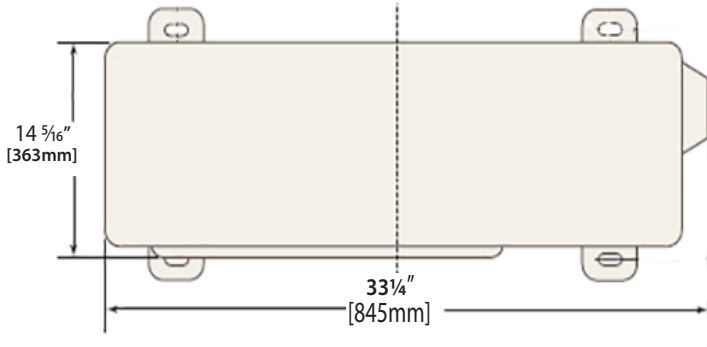
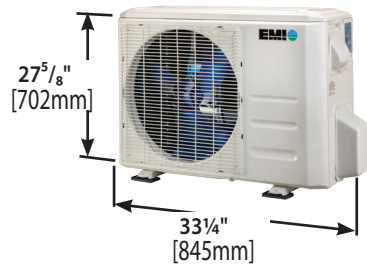

MZ1H27D & MZ1H36D

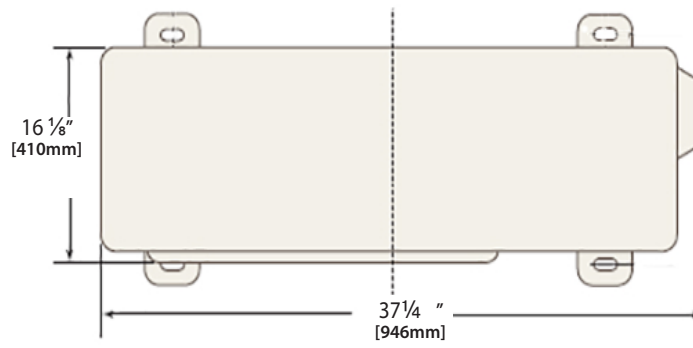
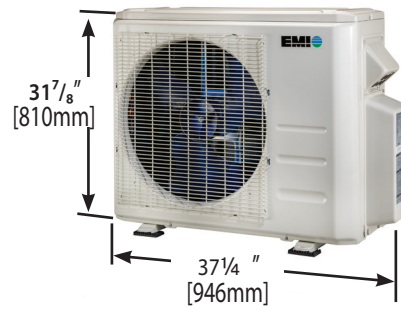

Multi - Zone Systems

208V-230V 9-24k

Multi-zone System Condensers can use either
Wall Air Handler or Ceiling Cassette

Model Indoor			WALH09D	WALH12D	WALH18D	WALH24D
Power Supply	V-Hz-Ph		208-230V-60Hz, 1Ph	208-230V-60Hz, 1Ph	208-230V-60Hz, 1Ph	208-230V-60Hz, 1Ph
Indoor air flow (Hi/Mi/Lo)	CFM		264/205/141	306/211/147	559/364/306	618/470/323
Indoor noise level (Hi/Mi/Lo)	dB(A)		36.5/30/25	36.5/30/25	43/38/32	47.5/42/33
Indoor Unit	Dimensions (W*D*H)	inches	31 ⁹ / ₁₆ x 7 ⁷ / ₁₆ x 11 ¹¹ / ₁₆	31 ⁹ / ₁₆ x 7 ⁷ / ₁₆ x 11 ¹¹ / ₁₆	42 ¹ / ₂ x 8 ⁷ / ₈ x 13 ³ / ₁₆	42 ¹ / ₂ x 8 ⁷ / ₈ x 13 ³ / ₁₆
	Dimensions (W*D*H)	mm	802 x 189 x 297	802 x 189 x 297	1080 x 226 x 335	1080 x 226 x 335
Refrigerant Piping	Liquid side/Gas side	mm(inch)	6.35 x 9.52 (1/4" x 3/8")	6.35 x 12.7 (1/4" x 1/2")	6.35 x 12.7 (1/4" x 1/2")	9.52 x 15.9 (3/8" x 5/8")
Thermostat Type - Standard - Supplied with unit			Handheld Remote Control	Handheld Remote Control	Handheld Remote Control	Handheld Remote Control
Thermostat Type - Optional Wired Wall - Purchase separately			Wall Thermostat	Wall Thermostat	Wall Thermostat	Wall Thermostat

WALH09D & WALH12D

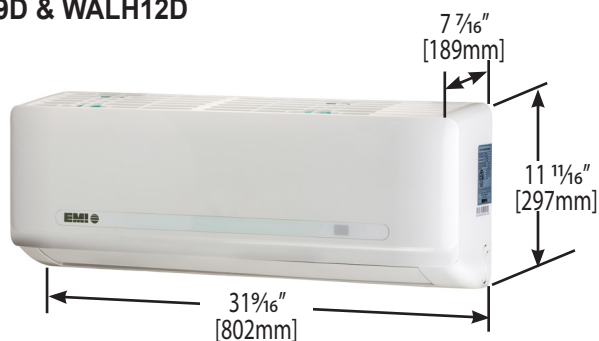

WALH18D & WALH24D

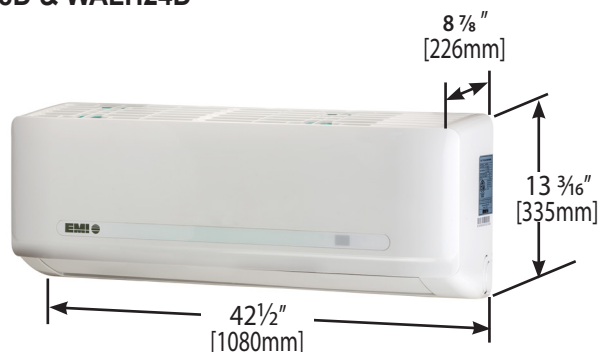

Multi - Zone Systems

208V-230V 9-24k

Multi-zone System Condensers can use either
Wall Air Handler or Ceiling Cassette

Model Indoor			CASH09D	CASH12D	CASH18D	CASH24D
Power Supply		V-Hz-Ph	208-230V-60Hz, 1Ph	208-230V-60Hz, 1Ph	208-230V-60Hz, 1Ph	208-230V-60Hz, 1Ph
Indoor air flow (Hi/Mi/Lo)		CFM	374/301/257	379/309/261	560/NA/NA	100/TBD/573
Indoor noise level (Hi/Mi/Lo)		dB(A)	41/37/33	43/39/36	44/39/36	51/47/43
Indoor Unit	Dimensions (W*D*H)	inches	22 ⁷ / ₁₆ x 22 ⁷ / ₁₆ x 10 ¹ / ₄	22 ⁷ / ₁₆ x 22 ⁷ / ₁₆ x 10 ¹ / ₄	22 ⁷ / ₁₆ x 22 ⁷ / ₁₆ x 10 ¹ / ₄	35 ⁷ / ₁₆ x 35 ⁷ / ₁₆ x 8 ⁹ / ₁₆
	Dimensions (W*D*H)	mm	570 x 570 x 260	570 x 570 x 260	570x 570 x 260	900 x 900 x 217
Indoor Unit Facia	Dimensions (W*D*H)	inches	28 ¹ / ₈ x 28 ¹ / ₈ x 4 ¹³ / ₁₆	28 ¹ / ₈ x 28 ¹ / ₈ x 4 ¹³ / ₁₆	28 ¹ / ₈ x 28 ¹ / ₈ x 4 ¹³ / ₁₆	40 ³ / ₄ x 40 ³ / ₄ x 3 ⁹ / ₁₆
	Dimensions (W*D*H)	mm	715 x 715 x 123	715 x 715 x 123	715 x 715 x 123	1035 x 1035 x 90
Refrigerant Piping	Liquid side/ Gas side	mm(inch)	6.35 x 9.52 (1/4" x 3/8")	6.35 x 12.7 (1/4" x 1/2")	6.35 x 12.7 (1/4" x 1/2")	9.52 x 15.9(3/8" x 5/8")
Facia Panel - Must be ordered with Cassette Unit - Packaged and sold separately.						
Facia Part Numbers			TMBQ403E	TMBQ403E	TMBQ403E	TMBQ02C1
Thermostat Type - Standard - Supplied with unit			Handheld Remote Control	Handheld Remote Control	Handheld Remote Control	Handheld Remote Control
Thermostat Type - Optional Wired Wall - Purchase separately			Wall Thermostat	Wall Thermostat	Wall Thermostat	Wall Thermostat

CASH09D, CASH12D, CASH18D

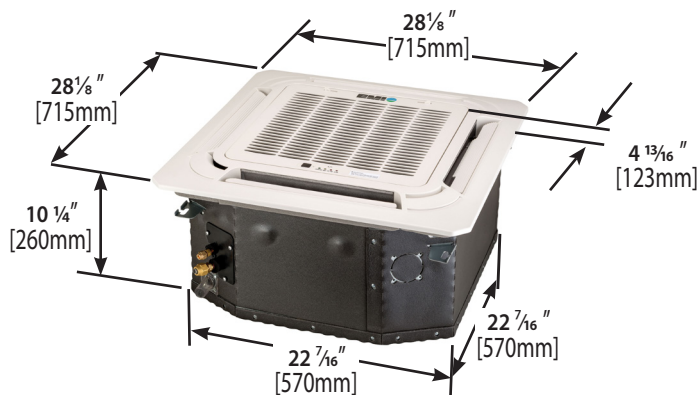

CASH24D

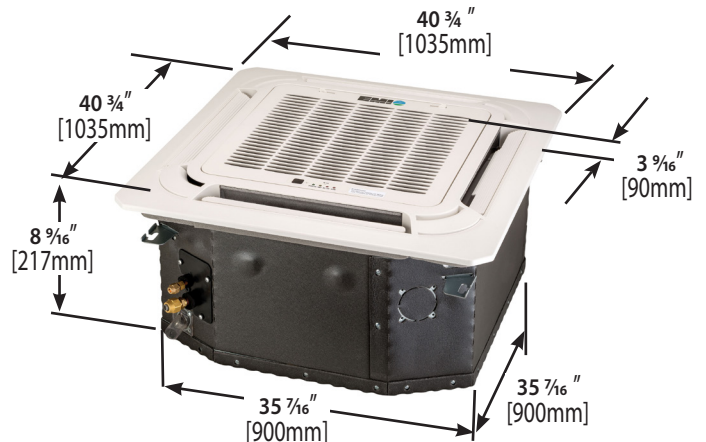

Handheld Remote Controller

Every EMI System comes with an easy to use handheld remote so you can adjust your comfort level at the touch of a button.

- Enabling "Follow Me" Technology. When "Follow Me" mode is activated, the system switches from air handler-mounted room temperature sensor, to the sensor inside of the infrared handheld remote control. The unit conditions the space where you are, with the remote close at hand.
- Enabling Timer Modes - On a schedule? Control variety of settings with precision through the Timer Mode. Never worry about arriving to a cold home again. If the system stops due to power outage, it will automatically restart to its last setting when the power comes back.



Optional Wired Wall Thermostat

Instead of a hand-held remote controller, the unit can be wired to I-verter wall mounted thermostat.



NOTICE: Due to ongoing product development; design, specification and performance data listed within this submittal document are subject to change without notice. Visit our website enviromaster.com for the most current performance data or consult the factory.



ECR international
EST. 1928
A Family of Heating & Cooling Brands.

ECR International, Inc.
2201 Dwyer Avenue,
Utica NY 13501
Phone: 800.325.5479
Web: enviromaster.com