

# HIGH EFFICIENCY DUCTLESS SPLIT SYSTEM WLC/WLH HIGH WALL EVAPORATOR

**STRAIGHT COOL/HEAT PUMP\***

**Nominal Circuit Capacities:**

**WLH 9,000, 12,000, 18,000, 24,000 Btuh  
and WLC (only) 30,000 & 36,000 Btuh**

*\* Heat Pump only available for 9,000-24,000 Btuh units.*



*Comfort Where It Counts.*

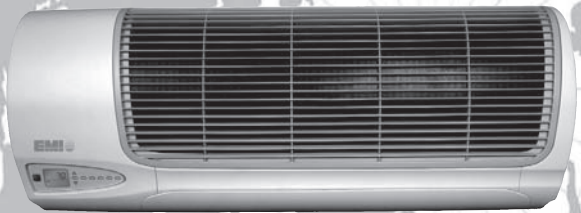

*WLC/WLH*

Enviromaster International LLC  
5780 Success Dr.  
Rome, NY 13440  
[www.enviromaster.com](http://www.enviromaster.com)

An  **ECR** International Brand  
An ISO 9001-2000 Certified Company



P/N# 240006021 Rev. 1.2 [09/06]

# WLC/WLH HIGH WALL HIGH EFFICIENCY EVAPORATOR

## INSTALLATION, OPERATION AND MAINTENANCE MANUAL

P/N 240006021, Rev. 1.2 [09/06]

This manual is intended as an aid to a qualified service personnel for proper installation, operation, and maintenance of EMI AmericaSeries high efficiency evaporators. Carefully read these instructions before attempting installation or operation. Failure to follow these instructions may result in improper installation, operation, service, or maintenance, possibly resulting in fire, electrical shock, property damage, personal injury, or death.

***Shipping Damage MUST be Reported to the Carrier IMMEDIATELY!!!  
Examine the carton for signs of damage if any is evident open packaging and check the unit for shipping damage.***

### TO THE INSTALLER

- (1) Retain this manual and warranty for future reference.
- (2) Before leaving the premises, review this manual to be sure the unit has been installed correctly and run the unit for one complete cycle to make sure it functions properly.

To obtain technical service or warranty assistance during or after the installation of this unit, check our website @ [www.enviromaster.com](http://www.enviromaster.com) or call your installing contractor or distributor. Our technical service department may be contacted at 1-800-228-9364.

When calling for assistance, please have the following information ready:

- Model Number \_\_\_\_\_
- Serial Number \_\_\_\_\_
- Date of installation \_\_\_\_\_

### DANGER

**Tampering with the EMI AmericaSeries evaporator is dangerous and may result in serious injury or death. Tampering voids all warranties. Do not attempt to modify or change this unit in any way.**

### SAFETY INSTRUCTIONS

- ▲ Read all instructions before using the EMI AmericaSeries high efficiency evaporator. Install or locate this unit only in accordance with these instructions. Use this unit only for its intended use as described in this manual.
- ▲ Check the rating plate on the EMI AmericaSeries evaporator before installation to make certain the voltage shown is the same as the electric supply to the unit.
- ▲ The EMI AmericaSeries evaporator must be connected only to a properly grounded electrical supply. Do not fail to properly ground this unit.
- ▲ Turn off the electrical supply before servicing the EMI AmericaSeries evaporator.
- ▲ Do not use the EMI AmericaSeries evaporator if it has damaged wiring, is not working properly, or has been damaged or dropped.

*[Save These Instructions]*

## PRODUCT DESCRIPTION

The AmericaSeries WLC/WLH is available as a (Dx) direct expansion straight cool and heat pump. It offers a contemporary design in a ductless type evaporator and combines attractive appearance with high efficiency conditioning for small to medium size commercial or residential spaces. The WLC/WLH is equipped with unit mounted infrared compatible controls which also supports 24V remote wall thermostat operation. Optional hand held remote is available.

Heat Pump models provide up to 23,000 Btuh of cooling and 20,600 Btuh of heating. Electric heat options are available for up to 5KW of supplemental heat.

This American-made evaporator offers ease of installation, operation, and service. It can be matched with EMI's S1C/S1H 09-24 and S1C 30-36 Btuh Single-Zone Condensing Units, the S2C side discharge Dual-Zone Condensing Unit, or the T2C, T3C, and T4C top discharge Multi-Zone Condensing Units.

All EMI Air Handlers are backed by Enviromaster International LLC and are tested and rated in accordance with ARI standards 210/240 and UL 1995.

## CONTROLS AND COMPONENTS

**Note: If the control is configured for unit mount control do NOT connect a wall thermostat to the unit.**

- **Large LCD Backlit Display**
- **Single unit mounted control package**, configurable to either unit mount or remote wall thermostat operation, reducing model number or SKU's required.
- **Universal control** can be used in cooling only, cooling with electric heat, heat pump, or heat pump with second stage electric heat applications.
- **Operational range** set point temperature adjustable between 55°F and 90°F in one-degree increments.

## CONTROLS AND COMPONENTS

*Continued*

- **Infra red compatible control** allows use of optional IR hand held controller.

**Note: Unit mounted controls are fully functional without the handheld remote.**

- **Operation modes** include Heat, Cool, Dry, Fan and Auto Change-over.
- **Fan Operation** – Auto/On. High or Low speed fan
- **Fan Purge** – Fan remains on for 60 seconds after Heat/Cool call is dropped for improved efficiency (Auto mode only)
- **Room air sampling:** Selectable time intervals ensure the fan will cycle on periodically, in Auto Fan Mode to help eliminate room temperature stratification.
- **Selectable Fahrenheit (°F) or Celsius (°C) temperature scale.**
- **Dry mode** – Operates cooling and electric heat simultaneously to remove humidity. Optional electric heat must be selected.
- **Anti-Short Cycle Compressor Protection.**
- **Minimum on time for heating and cooling** Helps eliminate room temperature drop and system short cycling.
- **Freeze Protection** – Prevents evaporator freeze up.
- **Test operation** – Allows ease of testing after installation (all timers are eliminated).
- **Non-volatile back-up memory** will maintain control settings for an indefinite period during a power outage. When power is restored the equipment will resume operation after a three-minute compressor time delay.
- **7-day programmable** with copy feature.
- **Filter change indicator:** A timer feature indicates when the filter should be changed according to the selected time.
- **Motorized supply louver** with optional sweep or six stationary settings.

## WLC/WLH CONTROLS AND COMPONENTS

*Continued*

- **Modular design** – reduces parts required for control package. Deco panel, relay board, ribbon cables and microprocessor are combined into one package.
- **Integral condensate pump safety-switch connection** where-by the microprocessor monitors the condensate pump safety switch and displays an error code when a fault occurs. (*Applies only with optional condensate pump*)
- **CEC** (California Energy Commission) compliant
- Condensate drain pan over flow protection

### ▲ **Cabinet Features:**

- Durable ABS plastic cabinet with a galvanized steel sub-chassis.
- Easily accessible, washable, reusable, nylon mesh filter.
- Horizontal discharge louver, constructed of high temperature ABS plastic, that can be set to oscillate, or can be parked in six pre-set positions.
- Manually adjustable vertical discharge fins.
- Easy access to pipe chase area from cabinet bottom allows piping connections and condensate pump installation with the unit mounted on the wall.
- Easily removable end-cap for access to control area for installation and service.
- Condensate drain pan constructed of galvanized steel (G90U), with anti-corrosion coating.
- Modular snap-in, 7-day programmable control with large backlit LCD display, a “Change filter” display feature and selectable Fahrenheit (F°), or Celsius (C°) temperature scale.

**NOTE:** Unit mounted controls are fully functional without the remote.

**NOTE:** If the control is configured for unit mount control do NOT connect a wall thermostat to the unit.

**IMPORTANT:** Check equipment for damage prior to installation, if damaged contact the wholesale distributor.

## OPTIONAL EQUIPMENT

- Condensate pump (*field installed only*)
- 24V remote wall thermostat
- Electric heat with automatic reset high temperature cutout and redundant high temperature fuse link (when heat option is selected)
- Hand held infrared controller.

## INSTALLER SUPPLIED ITEMS

- Low voltage wiring (*18 awg required*)
- High voltage power supply wiring
- Mounting screws and fasteners
- Condensate piping
- Refrigerant piping (if not supplied)
- Refrigerant (for interconnect charge)

## ITEMS FOR CONSIDERATION

- ▲ Determine the best location for mounting the unit for room air circulation.
- ▲ Locate outdoor and indoor units as close together as possible.
- ▲ Determine how power wire (high and low voltage) condensate drainage, and refrigerant piping may be run to and from the unit.
- ▲ **WLC/WLH** - Ensure that interconnect tubing is within the maximum allowable length of 100' including a maximum 35' lift.
- ▲ To ensure serviceability and proper air distribution, the unit should be positioned as close as possible to the center (left-to-right) of the wall. Minimum distance from the ceiling is stated on the template provided with the unit packaging. The cabinet left and right end caps must be accessible for removal without obstruction. (*See below*)

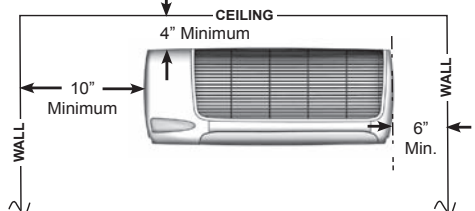

## WLC/WLH MOUNTING PREPARATION

The WLC/WLH must be mounted plumb and level to a vertical surface to prevent unit vibration and/or unwanted noise. It is recommended that the unit be mounted directly to a smooth surface such as Sheetrock® wallboard or similar material. If mounting to a masonry block wall, there should be a smooth barrier

between the unit and the masonry block surface to absorb any potential vibration and prevent the formation of condensation on the wall.

**NOTE:** *If excessive noise or vibration is experienced from a unit mounted to a masonry block wall, check to ensure the unit is plumb and level. If noise or vibration persists, contact the Wholesale Distributor.*

## WLC/WLH HIGH WALL UNIT MOUNTING

1. After determining the best location for the unit, use the cardboard template provided in the packaging.

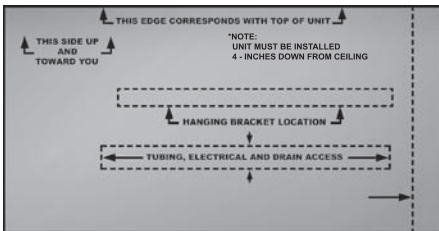

2. Mark where the piping, electrical wiring and condensate drain should penetrate the wall.
3. Determine the appropriate hole size and cut through the wall.
4. Use the supplied wall bracket. For shipping purposes, the wall bracket is fastened to the back of the unit.

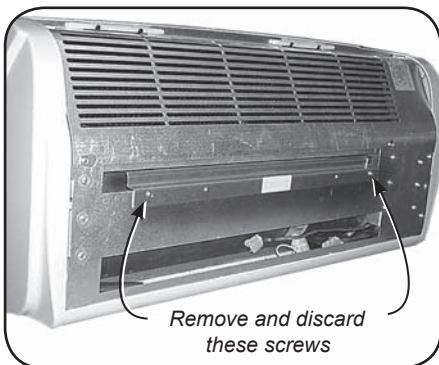

5. Secure the bracket to the wall with the appropriate screws (for wood) or anchors (for masonry). Ensure the bracket is mounted in a manner that will support the weight of the unit.

**Note:** *The wall hanging bracket slot is NOT located in the center of the unit.*

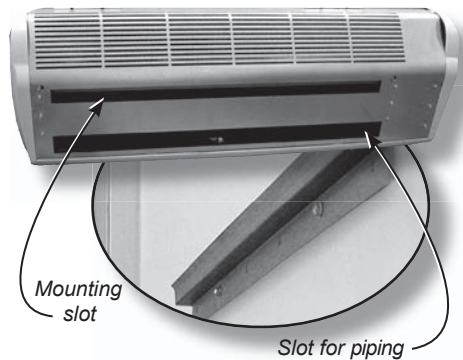

6. To mount the unit to the bracket, align the mounting slot on the back of the unit over the bracket and make certain it fits properly.

**NOTE:** *Piping may be roughed in before wallboard or panels are placed in new construction. PVC pipe (3" or 4" I.D.) may be used as a pipe chase.*

**NOTE:** *Panels should remain on the unit at all times, while powered and in operation. Service should be performed by a QUALIFIED service agency. An annual system check by a qualified service technician is recommended.*

# WLC/WLH HIGH WALL EVAPORATOR INSTALLATION INSTRUCTIONS

## Electrical Wiring Site Preparation

All wiring should be in accordance with the National Electric Code (NEC) and the local building codes.

1. **Make sure power is off.**
2. Check the unit rating plate for circuit ampacity and breaker or time delay fuse size. **Use only HACR type breakers.** Select the proper wire for the ampacity rating.
3. Each unit must have a separate branch circuit protected by a time delay fuse or breaker. Refer to the unit rating plate for the proper wire and breaker or time delay fuse size.

4. Inspect the existing wiring for any defects such as cut or frayed wires. Replace if any such wiring is found.

**NOTE: On units rated 208/230V, the primary side of the transformer is factory wired for 230V. For a 208V power supply, the transformer tap must be changed from orange to red. Refer to the wiring diagram located on the inside of the left end cap of the unit.**

## Locate Electrical Wiring

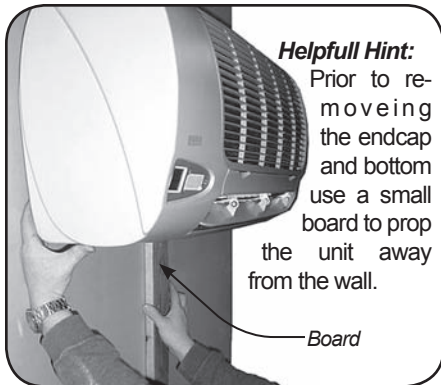

1. The left end cap of the unit needs to be removed to access wiring diagram and electrical wiring. This entails removal of three screws.

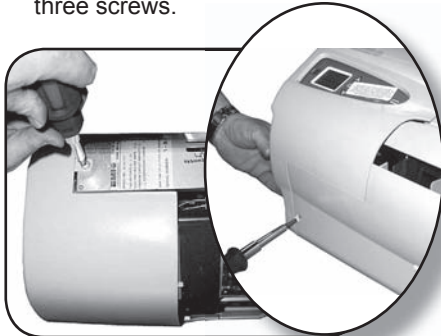

2. Lift and remove the front grill to expose the third screw.



3. Once the screws are removed, slide the left end cap off to expose control box and locate the wiring diagram on the inside of the end cap.

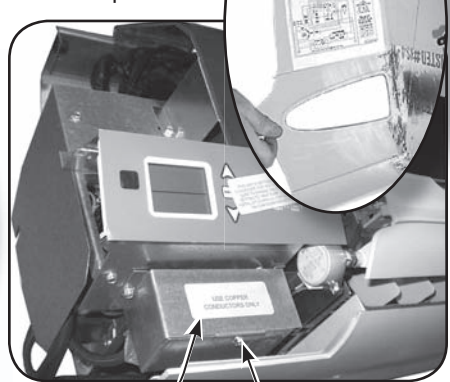

Control box

Remove screw

## WLC/WLH HIGH WALL EVAPORATOR INSTALLATION INSTRUCTIONS

- To access High and Low wiring remove the screw on the front of the control box.

### High Volt Electrical Wiring

- Refer to the wiring diagram to connect the power wire to Black L1 and the other wire to Red or White (115V) L2 at the power connector location.
- Connect the ground wire to the ground lug or lead at the same location in the control box.

### Low Volt Interconnect Wiring

*For Unit Mounted Controls*

**The 24V control transformer is located in the evaporator.** This provides low Volt control power to both the evaporator and condenser. Depending on the models selected, the **low Volt** interconnect control wiring may be effected.

**Note:** All low Volt interconnect wiring must be at least 18 awg.

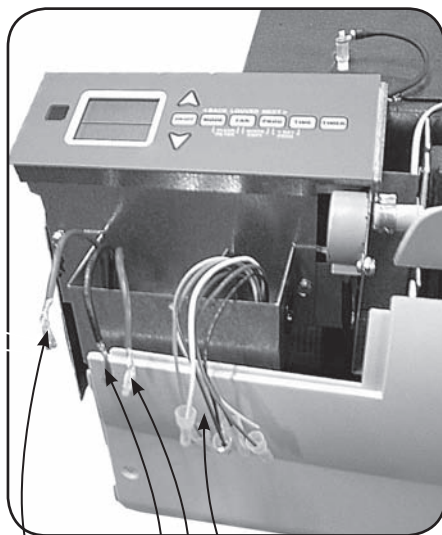

Ground  
L1  
L2

Low Voltage  
Connections

### WARNING!

Be sure to keep any un-used wires insulated with a wire nut or crimp.

## Units With Or Without Heat

**Cooling only units** utilize two **low Volt** interconnecting wires between the indoor and outdoor units.

- Wires designated "Y" (yellow) and "C" (brown) of the air handler should be connected to the corresponding "Y" (yellow) and "C" (brown) wires or terminals of the condenser. (See Figure 1A)
- Other wires or terminals such as "R" (red) or "O" (orange) may not be needed and should be protected by a wire nut from making contact with the junction box or other metal surfaces.

**Heat Pump Connection:** In addition to the "Y" and "C" connections required for cooling, heat pumps require a reversing valve control wire "O" (orange) that is energized in the cooling mode.

If the indoor unit has an electric heater, then a "W" (white) wire connection will also be needed to energize the indoor electric heat. If a remote thermostat is used.

Heat pumps models require an "R" connection between the indoor and outdoor unit to provide power to the defrost control board in the condenser. (See Figure 1B)

# WLC/WLH HIGH WALL EVAPORATOR INSTALLATION INSTRUCTIONS

## LOW VOLT INTERCONNECT WIRING FOR UNIT MOUNTED CONTROLS

### Units With Or Without Heat *Continued*

#### Unit Mount Controls *Straight Cool*

**Figure 1A**

#### Unit mount control configuration *Straight Cool Application*

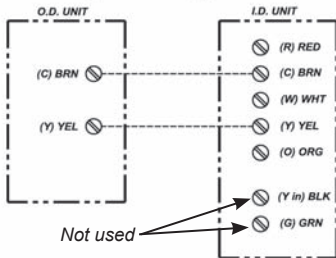

#### Heat Pump Connection Unit Mount Controls *Two-Stage Heating*

**Figure 1B**

#### Unit mount control configuration *Heat Pump Application*

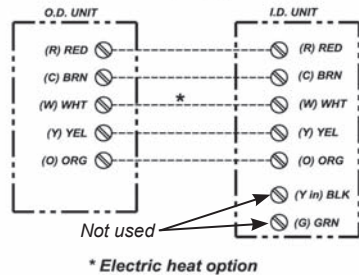

Low Volt interconnect diagram interconnect diagram **Figure 1A** and **Figure 1B** for unit mounted controls.

When connecting to a defrosting heat pump, such as EMI model S1H, indoor units with electric heat utilize five interconnecting **low Volt** wires between the indoor and outdoor units.

### Remote Thermostat Controls

The **24V** control transformer is located in the air handler unit. This provides low Volt control power to both the air handler and condenser. Depending on the models selected, the interconnect control wiring may be effected.

**NOTE:** All low Volt interconnect wiring must be at least 18 awg.

**NOTE:** For remote thermostat mode the key pad will have limited operation - Sequence of Operation - Wall Mounted Thermostat, page 21.

**Choosing a Remote Wall Mounted Thermostat:** See "Wall Thermostat Control" section page 21.

**Figure 2 A**

#### Remote wall mounted thermostat configuration *Straight Cool Application*

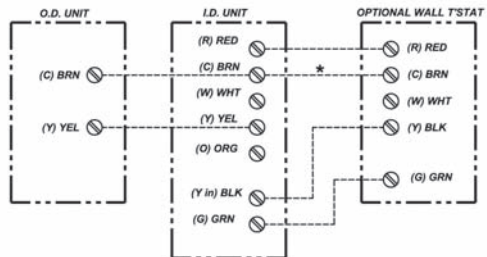

*\* Some thermostats do not use a "C" terminal*



# WLC/WLH HIGH WALL EVAPORATOR INSTALLATION INSTRUCTIONS

## Heat Pump Connection Remote Thermostat – Two-Stage Heating

Low Volt interconnect diagram interconnect diagram *Figures 2A, 2B & 2C* for remote wall thermostat control.

Depending on the thermostat required or selected, air handlers may utilize four to six **low Volt** interconnecting wires between the indoor unit, thermostat and outdoor unit.

Some thermostats do not require the use of the “C” (brown) connection. In this case, ensure that any unused wires are insulated with a wire nut to prevent them from making contact with the junction box or other metal surfaces.

If the indoor unit has electric heat then a “W” connection is required between the thermostat and indoor unit.

**NOTE: If the control is configured for unit mount control do NOT connect a wall thermostat to the unit.**

Refer to low Volt interconnect diagram interconnect diagram *Figures 2A, 2B & 2C* for remote wall thermostat controls.

- Some thermostats do not require the use of the “C” (brown) connection.
- Heat pump operation requires the connection of the “O” (orange) terminal from the outdoor unit to the thermostat.

The reversing valve is energized in the cooling mode for EMI models S1H heat pump condensers.

Ensure that any unused wires are insulated with a wire nut to prevent contact with the junction box or other metal surfaces.

**Once certin all electrical connections are made replace control box cover.**

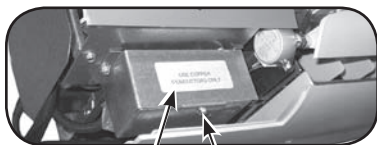

Control box — Replace screw

**Figure 2 B**

### Remote wall mounted thermostat configuration Cooling/Electric Heat Application

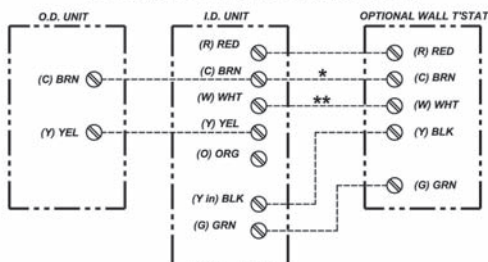

\* Some thermostats do not use a “C” terminal

\*\* Electric heat option

**Figure 2 C**

### Remote wall mounted thermostat configuration Heat Pump Application

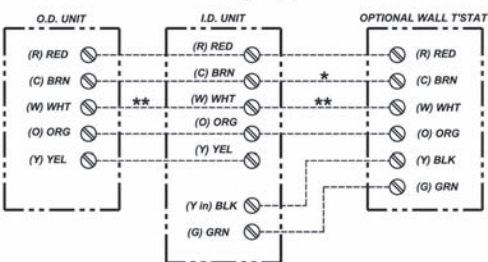

\* Some thermostats do not use a “C” terminal

\*\* Electric heat option

**SINGLE-ZONE HEAT PUMPS ONLY** Two-stage heating requires the combination of a heat pump condenser and an indoor unit that is equipped with an electric strip heater. The indoor electric heater will energize as the second stage heat source (the temperature is dependent on the thermostat selected) and also during the defrost mode for models S1H.

# WLC/WLH HIGH WALL EVAPORATOR INSTALLATION INSTRUCTIONS

## REFRIGERANT PIPING

### PIPING DO'S AND DON'TS

- Avoid piping on a rainy day.
- Use refrigerant grade copper tubing.
- Use a tubing bender and avoid unnecessary bending.
- Cap ends of lines until ready for final connections.

Once the unit is mounted and level the WLC/WLH piping connections can be made by removing the left end cap and bottom panel:

**Note:** *The left end cap must be removed prior to removing the bottom. Follow the instructions on page 6 for removing the end cap.*

1. Remove the Philips-head screws on bottom of unit and lift bottom panel off.

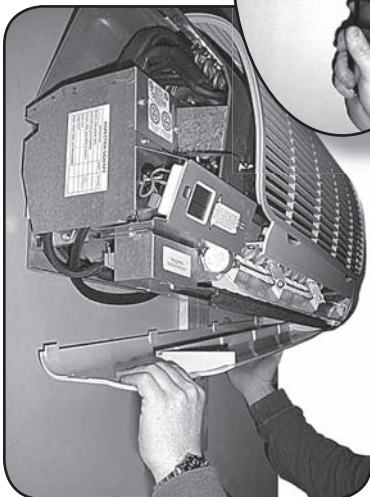

The WLC/WLH is equipped with a Flo-Rater/Piston Expansion device. Connections are sweat type.

The suction line (large) must be insulated the entire length with closed cell, foam tube insulation. Do not insulate the liquid line (small). Connect the outdoor unit according to the instructions supplied with unit.

All horizontal piping runs must be level and without dips to trap the oil.

2. Exposed piping and condensate drain connections. (See table on page 36 for connection size per unit capacity.)

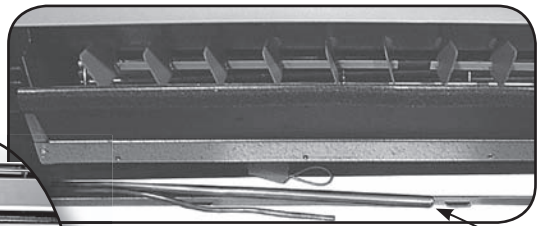

Liquid line

Suction line

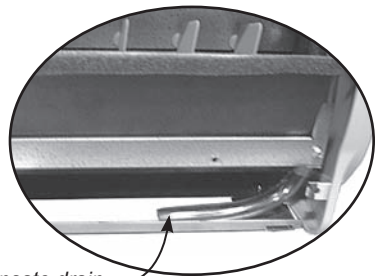

Condensate drain

When matching a the WLH24 with an 18,000 Btuh condenser circuit, the interconnecting suction line needs to be 5/8" O.D. to match the condenser service valve connection. Therefore the 3/4" O.D. suction connection of the WLH24 unit needs to be reduced to 5/8" at the WLH24 unit connection.

## REFRIGERANT PIPING

Any change in the diameter of the tubing **must be made at the indoor connection**. Line-set diameter is determined by the condenser service valve size.

**Use of a larger diameter liquid or suction line can harm the compressor!**

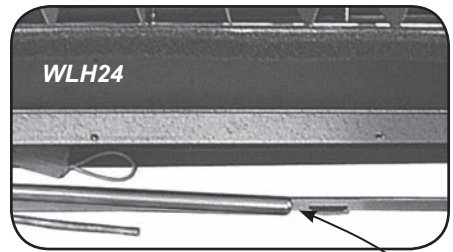

Reducing bushing goes here for 18,000 Btu/h system match

## PISTON/ORIFICE INSTALLATION INSTRUCTION

**Important:** Replace the existing piston (**before** installing the unit) with the piston supplied in Kit Bag when any:

- WLHA24 evaporator is matched with a S1CA8000 or S1HA8000 condenser which has an 18,000 Btu/h compressor ("8" in the capacity decoding field). The piston will need replacement **only** on the 18,000 Btu/h zone.\*

Your EMI evaporator unit contains the appropriate piston for your model. Refer to this document to determine if a change is required based on your condenser rating. If your match is **not listed below no piston change is required**. (See chart below)

### PROPER INSTALLATION OF PISTON/ORIFICE REPLACEMENT

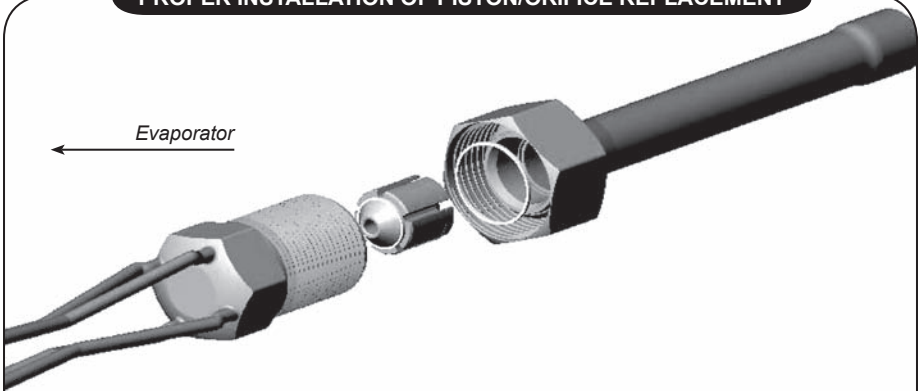

Model # Evaporator	Condenser Btu/h	Factory Installed Piston/Orifice Size	Field Changeover Piston/Orifice Size
WLHA24	S1CA8000	.059"	.053"
WLHA24	S1HA8000	.059"	.053"

\* "8" in the capacity decoding field = 18,000 Btu/h

## REFRIGERANT PROCESSING

### WARNING!

*It is illegal to discharge refrigerant into the atmosphere. Use proper reclaiming methods and equipment when installing or servicing this unit.*

### Finish all pipe connecting before proceeding to charging the system.

Follow the instructions in the outdoor unit for line evacuation, opening service valves, and final charge adjustments. Operation charts and charge tables can be found in the EMI Condenser IOMs.

1. Clean the ends of tubing and insert into fittings.

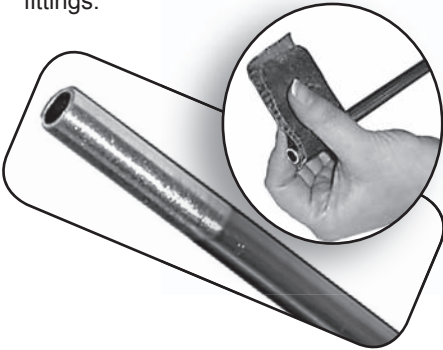

2. Protect the valves by wrapping with a wet rag "heat sink" before brazing.

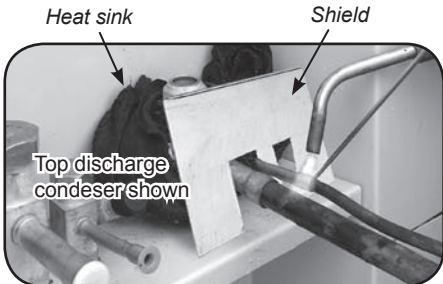

3. We recommend the use of a shield (can be made from some scrap metal) to protect the paint.

4. Braze tubing into fittings.

5. Attach manifold set.

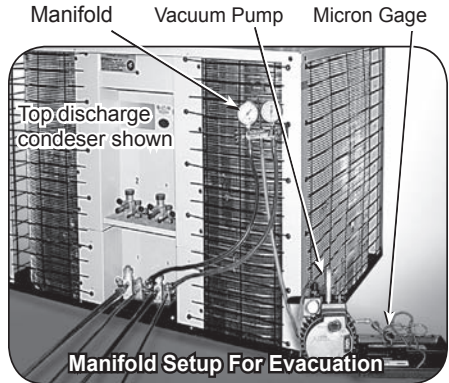

6. Evacuate line to 500 microns or less to ensure all moisture has been removed and there are no leaks.

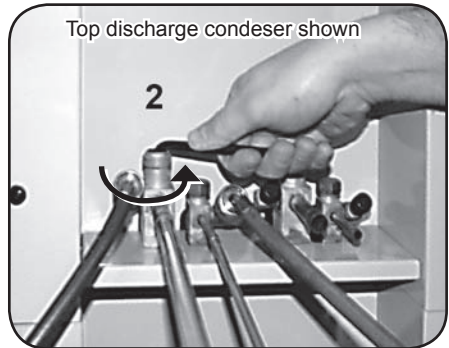

7. Once certain of a good evacuation and leak free joints, back-seat the valves (counter-clockwise) to open and allow factory charge to fill lines and indoor unit.

*Refer to Charts in condenser manual to "fine tune" the refrigerant charge.*

# WLC/WLH HIGH WALL EVAPORATOR INSTALLATION INSTRUCTIONS

## REFRIGERANT PROCESSING

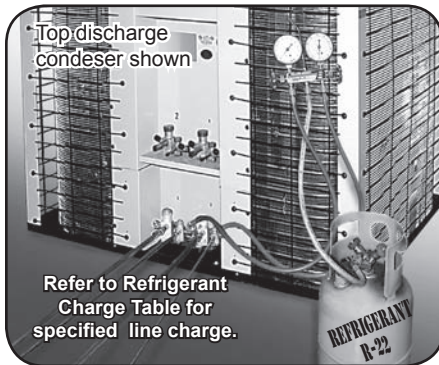

- Charge to proper weight, charge based on your feet of interconnect (see below).

**Note:** Charging should be done with a dial-a-charge or weighed in with a scale.

### IMPORTANT NOTES:

- To find the charge adjustment and system charge for any evaporator and tubing length:  

$$\text{Line Adjustment} = (\text{Line Chg/Ft}) \times \text{Line Length}$$

$$\text{System Total} = \text{Factory Charge} + \text{Line Adjustment}$$
- Round to the nearest ounce and allow for gauges and hoses.
- Use R22 refrigerant.

TOP DISCHARGE REFRIGERANT CHARGE CHART			
Circuit Capacity	Line Chg/Ft	Factory Charge	Ref.
09	.25 oz.	28 oz.	R-22
12	.25 oz.	30 oz.	R-22
18	.56 oz.	48 oz.	R-22
24	.56 oz.	60 oz.	R-22

S1C REFRIGERANT CHARGE TABLE			
Condenser	Evaporator Pairing	Line Chg/Ft	Factory Charge
S1CA9	WLHA09	.25 oz.	37 oz.
S1CA2	WLHA12	.25 oz.	40 oz.
S1CA8	WLHA24	.56 oz.	51 oz.
S1CA4	WLHA24	.56 oz.	65 oz.
S1CA3	WLCA30	.56 oz.	72 oz.
S1CA6	WLCA36	.56 oz.	90 oz.

S1H (HEAT PUMP) REFRIGERANT CHARGE TABLE			
Condenser	Evaporator Pairing	Line Chg/Ft	Factory Charge
S1HA9	WLHA09	.25 oz.	41 oz.
S1HA2	WLHA12	.25 oz.	44 oz.
S1HA8	WLHA24	.56 oz.	53 oz.
S1HA4	WLHA24	.56 oz.	67 oz.

S2C REFRIGERANT CHARGE TABLE			
Condenser	Evaporator Pairing	Line Chg/Ft	Factory Charge
S2CA99	WLHA09	.25 oz.	28 oz./ 28 oz.
S2CA22	WLHA12	.25 oz.	33 oz./ 33 oz.
S2CA92	WLHA09+WLHA12	.25 oz.	28 oz./ 33 oz.

# WLC/WLH HIGH WALL EVAPORATOR INSTALLATION INSTRUCTIONS

## REASSEMBLING THE WLC/WLH CABINET

When satisfied that the system is leak free reinstall the bottom and left end cap in the precise order shown below:

1. Replace the bottom panel.

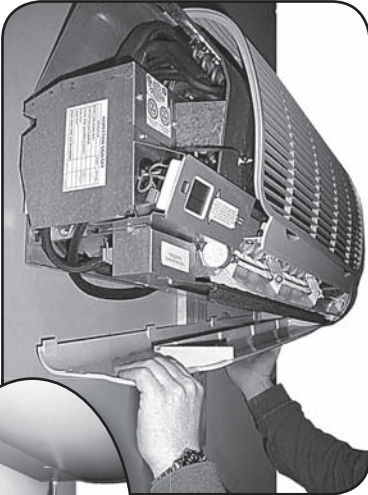

2. Fasten the right end cap side first with the Phillips-head screw.



3. Next replace and tighten the remaining screws across the bottom panel.



4. Replace left left end cap.

*Ensure seam is tight.*



5. Once end cap is properly seated tighten the screw as shown above.



6. Tighten bottom end cap screw.



7. Replace the grille, ensure it's seated properly on the unit.



8. Tighten the top screw on the left end cap.

## CONTROL USER INTERFACE INSTRUCTIONS

### QUICK GUIDE – USER INTERFACE BUTTONS

“**MODE**” button = select mode of operation, Cool, Heat, Auto changeover (ACO), Dry or Fan mode.

“**UP**” arrow button = increase set point temp., also = increment settings in Config., Time Set + Prog. modes.

“**ON/OFF**” button press once = unit on or off.

“**DOWN**” arrow button = decrease set point temp. also = decrement settings in Config., Time Set + Prog. modes.

“**TIMER**” button = enter or exit Sleep Timer mode.

“**TIME**” button = enter or exit Set Time mode.

“**PROG**” button = enter or exit Pre-prog. Run mode.

“**FAN**” button = select fan speed, High, Low or Auto.

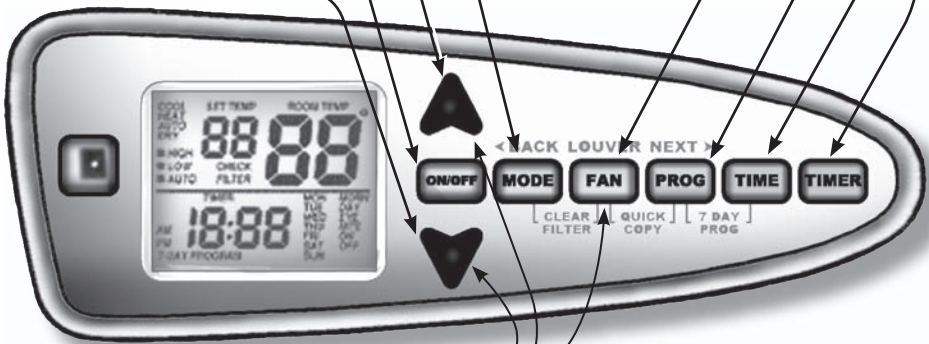

“**FAN/LOUVER**”

button press & hold for 3 seconds = “LOU” on LCD, then UP & DOWN ARROW = positions

### Quick Guide – Configuration Mode

“**FILTER CHECK**” Is flashing: press “**MODE**” + “**FAN**” buttons simultaneously for 3 sec. = clear warning.

“**QUICK COPY**” = 7-Day Prog. mode, press “**FAN**” + “**PROG**” buttons simultaneously for 3 sec. to copy selected day to rest of week.

**TEST MODE:** In Off mode, press “**ON/OFF**” + “**PROG**” + “**TIME**” buttons simultaneously for 3 sec. = Test mode. Press “**ON/OFF**” + “**PROG**” + “**TIME**” buttons simultaneously again = exit Test mode.

**7-DAY PROGRAM:** In Off or Run mode, press “**PROG**” + “**TIME**” buttons simultaneously for 3 sec. = 7-Day Prog. mode. Press “**PROG**” + “**TIME**” buttons again or if left idle for 20 sec. = exit 7-Day prog. mode.

**CONFIGURATION MODE:** in Off mode, press “**MODE**” + “**PROG**” buttons simultaneously for 10 sec. = Config. mode. Press “**MODE**” + “**PROG**” buttons again or if left idle for 20 sec. = exit Config. mode.

### USER INTERFACE BUTTONS

#### ON/OFF

Pressing the “**ON/OFF**” button once will switch the unit either on or off.

#### MODE

The “**MODE**” button allows the selection of the mode of operation, Cool, Heat, Auto changeover (ACO), Dry or Fan mode.

## CONTROL USER INTERFACE INSTRUCTIONS

### USER INTERFACE BUTTONS

#### FAN

The “**FAN**” button will select the fan speed, High, Low or Auto. High and low are constant fan speed settings and can be selected in all modes except Dry mode. In Dry mode, the fan will operate constantly at low speed. Auto fan mode is not available in Fan (only), Dry and Remote wall thermostat modes.

#### PROG

The “**PROG**” button is used to enter or exit the Pre-program Run mode. The Pre-program Run mode can be entered while the control is in “Cool”, “Heat” or “Auto” modes. Pre-program Run mode can not be entered while in Dry, Fan or Off modes. While the control is in Pre-program Run mode the word “PROGRAM” will be displayed on the LCD.

#### TIME

The “**TIME**” button is used to enter or exit the Set Time mode. The Set Time mode can be entered while the control is in any mode including Off mode. To enter the Set Time mode, press and hold the “TIME” button in for three seconds. To exit press the “TIME” button momentarily.

#### TIMER

The “**TIMER**” button is used to enter or exit the Sleep Timer mode.



#### UP ARROW

The “**UP**” arrow button is used to increase the set point temperature. Also, the “UP” arrow button is used to increment settings in the Configuration, Time Set, Program and Louver Set modes.



#### DOWN ARROW

The “**DOWN**” arrow button is used to decrease the set point temperature. Also, the “DOWN” arrow button is used to decrement settings in the Configuration, Time Set, Program and Louver Set modes.

#### LOUVER

The Fan/Louver button is used to enter the louver mode. The louver mode allows selection of six different fixed louver positions or auto (oscillation) louver mode.

To enter the louver mode press and hold the Fan/Louver button for three seconds. While in louver set mode the word “Lou” will display on the LCD.

### ALTERNATE BUTTON SELECTIONS

#### Clear Filter

When the “**FILTER CHECK**” indicator warning is flashing on the LCD, pressing the “MODE” and “FAN” buttons simultaneously for three seconds will clear the warning.

#### Quick Copy

While in 7-day programming mode, pressing the “FAN” and “PROG” buttons simultaneously for three seconds will copy the selected day to the rest of the week.

#### 7-Day Program

When the unit is either in the Off or Run mode, pressing the “PROG” and “TIME” buttons simultaneously for three seconds will enter the 7-Day Programming mode. Pressing the “PROG” and “TIME” buttons again or if left idle for 20 seconds, will exit the 7-Day program mode.

#### Configuration Mode

When the unit is in the Off mode, pressing the “MODE” and “PROG” buttons simultaneously for 10 seconds will enter the Configuration mode. Pressing the “MODE” and “PROG” buttons again or if left idle for 20 seconds, will exit the Configuration mode.

#### Test Mode

When the unit is in the Off mode, pressing the “ON/OFF”, “PROG” and “TIME” buttons simultaneously for three seconds will enter Test mode. Pressing the “ON/OFF”, “PROG” and “TIME” buttons simultaneously again will exit Test mode

**CAUTION:** Do not cycle the unit on and off repeatedly while in Test mode as this will cause damage to the compressor. Do not leave the unit in Test mode.



### Unit Mount Infrared Control Operation

EMI Air Handlers are equipped with a unit mount, infrared compatible control package. This user friendly, microprocessor control is designed to optimize system performance and protect the refrigeration system from unwanted short cycling and evaporator freeze-ups. Operation of the unit can be made by **either the keypad on the unit or by using the optional hand held infrared controller.**

For unit mounted key pad operation the control must be configured through the Configuration mode. Be sure to select Remote – OFF in the configuration menu. (See Configuration mode)

**Note:** *When power is first applied to the control or after a power outage there is a three minute delay before the compressor or electric heat will energize. This is to protect the unit from short cycling due to loss of power.*

### On/Off

Pressing the “**ON/OFF**” button once will switch the unit either on or off. In the Off mode, the LCD will display the time of day and day of the week. In the On mode the LCD display will also display the room temperature and the mode of operation Cool, Heat, Auto (Auto changeover), Dry or Fan mode. While in the On mode, the set point temperature will display momentarily with the push of any button except the ON/OFF button.

### Mode of operation

The “**MODE**” button allows the selection of the mode of operation, Cool, Heat, Auto changeover (ACO), Dry or Fan mode. In Fan mode either “HIGH” or “LOW” will be displayed on the LCD.

### Fan Operation

The indoor unit utilizes a two-speed motor with three operational fan modes.

The FAN button will allow the selection of the desired fan setting in all modes except Dry mode. In Dry mode, the fan will operate constantly at low speed. The LCD will indicate fan speed selection.

High and Low are constant fan settings. The fan will operate continuous regardless of set point or room temperatures. Auto mode is for cycling fan operation.

Auto Fan mode can only be selected if the unit is in Heat, Cool or Auto Change-over modes. In Auto Fan mode the fan will cycle with the call for Heat or Cool. Fan speed will be determined by the microprocessor and speed adjustment will be made according to room and setpoint temperatures. The fan will switch to High speed when room temperature deviates by more than two degrees from setpoint. The fan will switch to Low speed if the deviation is one degree or less. When the room temperature reaches setpoint temperature the heat/cool call will then be dropped. The fan will stay on for an additional 60 sec. to purge unit of any residual energy.

If the Room Air Sampling feature has been enabled in the Configuration mode (see Configuration mode), after the fan has been off for the selected time, it will then cycle on for 60 seconds. The unit will circulate room air to remove any temperature stratification by the unit so the microprocessor can determine an accurate room temperature. After the 60 second room air sample time has elapsed, and if the setpoint temperature remains satisfied, the fan will cycle off.

When the unit is in Dry mode the fan speed will remain constant at Low speed. While the unit is in Fan mode, Auto is bypassed and only High or Low are available.

### Louver Operation

When the control is in the Off mode the louver will remain in the closed position. When the unit is turned on via the ON/OFF button the louver will open and operate according to the setting selected in the Louver Configuration mode.

To enter the Louver Configuration mode, press and hold the Fan/Louver button in for three seconds. This will enter the Louver Configuration mode and “Lou” will display on the LCD. Pressing the Up

## SEQUENCE OF OPERATION – UNIT MOUNTED KEY PAD MODE

or Down arrow buttons will allow selection of six different fixed louver positions or auto (oscillation) mode. The sequence is 01, 02, 03, 04, 05, 06 and Auto. Once the desired setting is selected, press the Fan/Louver button momentarily or let idle for 10 seconds to exit the louver set mode.

While the control is in the On mode, the louver will remain in the selected louver position. If Auto louver operation is selected, the louver will oscillate only when the fan is running. When the control is turned off via the ON/OFF button the louver will return to the closed position.

### Cool Mode

For cooling operation first turn the unit on via the ON/OFF button. Select Cool mode via the MODE button. The room temperature and set point temperature will be displayed. The setpoint temperature can be changed with each successive press of the Up or Down arrow buttons or by holding the button in.

Place the setpoint temperature below the room temperature. The compressor will start and cooling will continue for a minimum of two minutes and as long as the setpoint remains below room temperature. Once the room temperature is satisfied for at least 60 seconds and the two-minute minimum run time has elapsed the compressor will cycle off. The fan will operate as described in "Fan Operation".

**NOTE:** *Once the compressor is switched off, or after a power outage there is a three-minute delay before the compressor will re-start.*

### Heat Mode

#### ▲▼ **Optional Electric Heat Operation** (Non Heat pump condenser units only):

For operation with electric heat the control must first be configured properly (Heat source – "ON", Heat pump – "OFF"). See: *Configuration Interface mode.*

For electric heat operation, first turn the unit on via the ON/OFF button. Then select Heat mode via the MODE button. The

room temperature and setpoint temperature will be displayed. Press either the Up or Down arrow buttons to change the setpoint temperature. The setpoint temperature will change by one degree with each successive press of the Up or Down arrow buttons. Holding the button in will change the temperature rapidly.

Place the setpoint temperature above room temperature. The electric heat will energize and heating will continue as long as the setpoint remains above room temperature. When the room temperature has been satisfied for at least 60 seconds and the two minute minimum on time has expired, the electric heat will switch off. The fan will operate as described in "Fan Operation".

#### ▲▼ **Optional Heat Pump With Electric Heat (2-stage heating):**

For heat pump operation with electric heat the control must first be configured properly (Heat source – "ON", Heat pump – "ON"). See: *Configuration Interface mode.*

For heat pump operation with backup electric heat, first turn the unit on via the ON/OFF button. Then select Heat mode via the Mode button.

The room temperature and setpoint temperature will be displayed. Press either the Up or Down arrow buttons to change the setpoint temperature. The setpoint temperature will change by one degree with each successive press of the Up or Down arrow buttons. Holding the button in will change the temperature rapidly.

Place the setpoint temperature above the room temperature by one degree. The compressor will start and heating will continue for a minimum of two minutes and as long as the setpoint remains above room temperature. When the room temperature has been satisfied for at least 60 seconds and the minimum on time has elapsed, the compressor will switch off. The fan will operate as described in "Fan Operation".

Next, place the setpoint temperature above the room temperature by at least two degrees. The compressor will start and, the electric will also energize after a 30 second delay, thus two-stage heating. The electric heat will run for a minimum of two minutes and until the deviation

## SEQUENCE OF OPERATION – UNIT MOUNTED KEY PAD MODE

between room temperature and setpoint temperature is less than two degrees. At that time the electric heat will switch off and the heat pump (compressor) will take over the heating demand. The electric heater will not re-start until a three minute delay has elapsed. Once the room temperature is satisfied and the two-minute minimum run time has elapsed, the compressor will cycle off. The compressor will not re-start until a three minute delay has elapsed. The fan will operate as described in “Fan Operation”.

### Dry Mode

For **Dry Mode** operation the unit must have an electric heater. Also the control must first be configured properly (Heat source – “ON”). See: Configuration Interface mode.

Dry mode will remove humidity from the air while maintaining a specific setpoint temperature. This is done by energizing the compressor in cooling along with the electric heater. Dry mode will not maintain a specific humidity level. The unit must be equipped with an optional electric heat element.

For Dry Mode operation, first turn the unit on via the ON/OFF button. Select Dry mode via the MODE button. The room temperature and setpoint temperature will be displayed. Press either the Up or Down arrow buttons to change the setpoint temperature. The setpoint temperature will change by one degree with each successive press of the Up or Down arrow buttons. Holding the button in will change the temperature rapidly.

Place the setpoint temperature at a desired room temperature. Depending on the difference between room temperature and setpoint temperature the compressor and/or heat source will energize. If the room temperature and setpoint temperature are the same the compressor will operate in cooling and the electric heat will also energize.

Should the room temperature fall below the setpoint temperature by two degrees, the compressor will stop and heating will continue to boost the room temperature back up to setpoint temperature. If the room temperature rises above the setpoint tem-

perature by two degrees, heating will stop and cooling will continue to bring the room temperature back down to setpoint temperature. The fan will operate continuously at low speed while in Dry Mode.

In order to prevent short cycling there is a two minute minimum on time for both cooling and heating. The minimum off time is 3 minutes. Also there is a 30 second delay between the start of the compressor and the start of the heat source.

### Auto Changeover Mode

For **Auto Changeover Mode** (ACO) the unit must have a heat source. Also the control must first be configured properly (Heat source – “ON”). See: Configuration Interface mode.

Auto Changeover mode will operate either Cooling mode or Heating mode. The control will select the mode of operation depending on the setpoint temperature, room temperature and the differential setting selected in the Configuration mode (See Configuration mode).

For Auto Changeover mode, first turn the unit on via the ON/OFF button. Select Auto mode via the Mode button. The room temperature and setpoint temperature will be displayed. Press either the Up or Down arrow buttons to change the setpoint temperature. The setpoint temperature will change by one degree with each successive press of the Up or Down arrow buttons. Holding the button in will change the temperature rapidly.

Place the setpoint temperature below the room temperature by the dead band amount selected in the configuration mode. The compressor will start and the unit will run cooling operation as described under “Cool Mode”.

If the set point temperature is above the room temperature by the dead band amount selected in the configuration mode, the unit will run heating operation as described under “Heat Mode”

### Set Time Mode

The “TIME” button is used to enter or exit the Set Time mode. The Set Time mode can be entered while the control is in

## SEQUENCE OF OPERATION – UNIT MOUNTED KEY PAD MODE

any mode including the Off mode. To enter the Set Time mode, press the “TIME” button in for three seconds. Pressing the “PROG” (NEXT) button will advance to the next item. The order is (1) Day of week, (2) Hour and (3) Minute. Pressing the “MODE” (BACK) button will return to the previous item. The time of day and day of week can be changed using the up or down arrow buttons.

When the “TIME” button is pressed again or left idle for 20 seconds, the control shall save the new settings and return to the previous mode.

### 7-Day Programming Mode

The 7-day programming mode is used to store the settings for the Pre-program Run mode.

When the unit is in either the Off or Run mode, the 7-Day Programming mode can be entered by pressing the “PROG” and “TIME” buttons simultaneously for three seconds. When the “PROG” and “TIME” buttons are pressed simultaneously again or left idle for 20 seconds, the control shall save the new settings and return to the previous interface mode.

While in the 7-Day programming mode, use the up or down arrows to change the time, temperature or period settings. Use the “MODE” (BACK) or “PROG” (NEXT) buttons to select the mode to be changed.

Settings for (1) Day of week, (2) Period of day, (3) Hour, (4), Minute, (5) Cool setpoint temperature, (6) Heat setpoint temperature and (7) Auto setpoint temperature can be entered.

### Quick Copy

Quick copy is a feature of the 7-day programming mode. It is used to copy the settings of any day to the rest of the week. While in 7-day programming, select the day to be copied. Then, press the “FAN” and “PROG” buttons simultaneously for three seconds. The selected day will be copied to the rest of the week.

### Manual Run

This is normal operating (non pre-program run) mode. Settings for temperature, mode and fan speed are selected by the user and will not change with the passing of time. The word “PROGRAM” does NOT display on the LCD.

### Pre-Programmed Run Mode

This feature allows the setpoint temperature to be changed according to the pre-programmed set point and time of day settings. The setpoint and time settings are programmed into the control through the 7-day programming interface.

The Pre-programmed Run mode can be entered from Cool, Heat or Auto modes only. Pre-programmed run mode cannot be entered from Dry or Fan modes. Pressing the “PROG” button momentarily will enter or exit the Pre-program run mode. The word “PROGRAM” will appear in the LCD display. Then, with the passing of time, the setpoint will change to the programmed setting at the time selected.

### Filter Check

To aid in filter maintenance, the micro-processor will keep track of the units run time. Then, after the filter check time has elapsed, a “FILTER CHECK” warning will appear the LCD display. The filter check time is selectable through the configuration mode. Available settings are 250, 500, 750, 1000, and 1250 hours. Also if four evaporator freeze ups occur within a 24 hour period, (See fault condition E03) the filter check indicator will appear.

After filter maintenance has been performed, press the “MODE” and “FAN” buttons simultaneously for three seconds to clear the filter check warning.

## SEQUENCE OF OPERATION – UNIT MOUNTED KEY PAD MODE

### Room Air Sampling

In the auto (cycling) fan mode Room Air Sampling will automatically cycle the fan on for a minimum of 60 seconds, with the control in the satisfied state, to periodically circulate room air. Room air stratification is therefore minimized due to the fan being off for long periods of time so that the microprocessor may accurately track room temperature.

Room air sampling must be selected through the configuration mode. Selectable sampling times are: "OFF" (disabled), 5 min, 10 min, and 15 min.

### Configuration Mode

While the unit is in the Off mode, pressing the "MODE" and "PROG" buttons simultaneously for 10 seconds will enter the Configuration mode. While in Configuration mode, pressing the "MODE" and "PROG" buttons simultaneously again or left idle for 20 seconds, will save the new settings and exit the Configuration mode.

The following table specifies the user selectable settings in the Configuration mode:

**Table #1 – CONFIGURATION MODE**

SETTING ITEM		LCD TITLE DISPLAY	POSSIBLE VALUE (Flashing)		FACTORY SETTINGS
1	Temperature scale	"01 F-C"	"F"	Fahrenheit	"F"
			"C"	Celsius	
2	Remote wall thermostat mode (pg. 21)	"02 r - t"	"ON"	Remote wall thermostat on	"OFF"
			"OFF"	Remote wall thermostat off	
3	Heat Source (pg.17)	"03 HEAT"	"ON"	Heat source available	"ON" If El. heat
			"OFF"	Not available	"OFF" If no El. Ht.
4	Heat pump (This setting is skipped if Heat source setting is "Off")(pg.17)	"04 H-P"	"ON"	Heat pump available	"OFF"
			"OFF"	Not available	
5	Auto-changeover differential (This setting is skipped if Heat source setting is "Off" or if remote setting is "On")(pg.18)	"05 d-b"	Between "2° – 6°"		"2"
6	Check filter time (pg.19)	"06 F:Lt"	"2"	250 hours	"10"
			"5"	500 hours	
			"7"	750 hours	
			"10"	1000 hours	
			"12"	1250 hours	
7	Room air sampling (pg. 20)	"07 A:r"	"OFF"	Disabled	"15"
			"5"	5 minutes	
			"10"	10 minutes	
			"15"	15 minutes	
8	Annunciation (pg.23)	"08 b-P"	"ON"	Enabled	"ON"
			"OFF"	Disabled	
9	LCD Backlight (pg.23)	"09 L:tE"	"ON"	Always on	"In"
			"In"	Intermittent	
			"OFF"	Always off	
10	Louver position	"Lou"	01, 02, 03, 04, 05, 06 and Auto		"01"
11	Test Mode	"tSt"	"tSt"		Off

## SEQUENCE OF OPERATION – UNIT MOUNTED KEY PAD MODE

### Sleep Timer

The SLEEP TIMER feature allows the user, with the push of a single button, to have the unit switch off using the preset timer. When the control is in the "On" mode, pressing the "TIMER" will enter or exit the Sleep Timer mode. When in Sleep Timer mode, the word "TIMER" will appear on the LCD display. The unit will continue to operate for thirty (30) minutes then switch off.

### Test Mode

Test mode is a feature where by all timers are reduced or eliminated. Test mode is intended to aid the technician while checking system operation after installation or during trouble shooting. Test mode is not intended for the end user or for normal operation. Also test mode is not available while in Remote Wall Thermostat mode".

To enter Test mode the control must first be in the Off mode. Then by pressing the "ON/OFF", "PROG" and "TIME" buttons simultaneously for three seconds the unit will enter the Test mode. While in Test mode the display will flash "tSt" periodically. The operation of the unit can be checked without having to wait out the delays. To exit the Test mode press the "ON/OFF", "PROG" and "TIME" buttons simultaneously again or by cycling off the main power to the control.

**CAUTION:** Do not cycle the unit on and off repeatedly while in Test mode as this will cause damage to the compressor. Do not leave the unit in Test mode

## SEQUENCE OF OPERATION – WALL MOUNTED THERMOSTAT MODE

For Wall mounted thermostat operation the control must be configured through the Configuration mode. Be sure to select Remote – ON in the configuration menu. (See Configuration mode)

In Remote Thermostat mode the unit mounted keypad will have limited capability. Some of the buttons will not be operable. Only the FAN and TIME buttons will function. The ability to clear the FILTER CHECK warning will also be available by pressing the MODE and FAN buttons simultaneously.

### ▲▼ Choosing a Thermostat:

EMI offers several remote thermostats that are compatible with the Ductless split system air handlers. See the latest price list for a list of available thermostats. It is important to choose a thermostat that will match the equipment that you have selected. For single stage cooling or heating choose a single stage Heat/Cool thermostat. If you have selected an outdoor heat pump unit and an indoor unit with

electric heat then chose a two-stage heating, single-stage cooling thermostat.

### ▲▼ Selecting a thermostat "by others"

When selecting a thermostat other than those offered by EMI, it is important to choose a 24V thermostat that matches your application. EMI equipment is compatible with most mercury bulb, digital or power steeling thermostats.

### ▲▼ Cooling Only:

Select a thermostat that is compatible with a cooling system. The thermostat should have "R", "Y" and "G" terminals and may also have a "C" terminal.

### ▲▼ Cooling only with Electric Heat:

Select a thermostat that is compatible with a cooling - electric heat system. The thermostat should have "R", "Y", "W" and "G" terminals. The thermostat may also have a "C" terminal.

**▲ Heat Pump with Electric Heat:**

Select a thermostat that is compatible with a single stage cooling, two-stage heat, heat pump system. The thermostat should have “R”, “Y”, “O”, “W (or W2)” and “G” terminals. The thermostat may also have a “C” terminal. If the indoor unit is not equipped with electric heat then a single stage heat pump thermostat is adequate.

**▲ Fan Operation**

The indoor unit utilizes a two-speed motor. The FAN button will allow the selection of the desired fan speed setting (High or Low). The wall thermostat will control the call for fan operation (On or Off) through the low volt terminals “R” and “G”.

After the room thermostat has been satisfied and the call for fan has been removed, the indoor fan to remain on for an additional 60 seconds. This increases efficiency by pulling the remaining energy from the unit.

Some thermostats are equipped with an “AUTO/ON” fan switch. When this switch is placed in the “ON” position the indoor fan will run continuous. When the switch is in the “AUTO” position the indoor fan will cycle with the call for heating or cooling.

**▲ Cooling operation:**

The wall thermostat will control the call for cooling operation (On or Off) through the low volt terminals “R” and “Y”. After connecting the thermostat to the unit, place the system switch in Cool mode. Adjust the set-point temperature below the room temperature. The compressor and fan motors will start and cooling will begin. Next, place the set-point temperature above the room temperature. The outdoor condenser will stop. The fan will operate as described in Fan Operation.

**Note:** Once the cooling has cycled off or following a power outage, the compressor will not start for at least three minutes (See Short Cycle Protection).

**▲ Electric heat operation:**

For remote thermostat operation with electric heat the control must first be configured properly (Remote – ON, Heat source – “ON”). See: Configuration Interface mode.

The wall thermostat will control the call for electric heat operation (On or Off) through the low volt terminals “R” and “W”. After connecting the thermostat to unit, place the system switch in Heat mode. Adjust the set-point temperature above the room temperature. The electric heat will energize along with the indoor fan motor. Heating will continue so long as the set-point remains above room temperature. Next, place the set-point temperature below room temperature. The Electric heater will switch off and the indoor fan will remain on for an additional sixty seconds.

**Note:** Once the heating has cycled off or following a power outage, the heating will not resume for at least three minutes (See Short Cycle Protection).

**▲ Optional Heat Pump With Electric Heat (2-stage heating):**

For remote thermostat operation for two stage heating including a heat pump condenser and indoor electric heat, the control must first be configured properly (Remote – ON, Heat source – “ON”). See: Configuration Interface mode.

The wall thermostat will control the call for electric heat operation (On or Off) through the low Volt terminals “R” and “W” for compressor (heat pump) heating through terminals “R” and “Y”. After connecting the two stage heating thermostat to the unit, place the system switch in Heat mode. Adjust the set-point temperature above

the room temperature. The compressor and fan motors will start and heating will begin. Depending on the thermostat selected, electric heat will also energize when the deviation between room temperature and set point temperature is high enough to call for second stage heating. (See the thermostat owner's manual for this feature) Place the set-point temperature below the room temperature. The outdoor condenser and electric heat will stop while the indoor fan will remain on for an additional sixty seconds.

### Other Features

#### ▲▼ **Short Cycle Protection (ASCT):**

The electronic control incorporates an anti-short cycle timer (ASCT) feature designed to protect the compressor from short cycling. The ASCT is activated immediately following the off cycle of the outdoor unit. Once the room temperature is satisfied and the outdoor unit switches off, the ASCT will not allow the outdoor to restart unit a three-minute time period has elapsed.

This feature will prevent the compressor and heat source from rapid re-starts. Once switched off, including following a power outage, the compressor or heat source shall not re-start for a minimum of three minutes.

#### ▲▼ **Staggered Start Protection:**

Designed for systems with electric heat, in heat pump and dry modes the staggered start feature will prevent the compressor and electric heater from starting simultaneously. There is a thirty-second delay between the start of the compressor and start of the electric heater while in Dry mode and Heat pump mode.

#### ▲▼ **Minimum Run Time:**

Once started, the minimum on time prevents either the compressor or heat source from cycling off prematurely. The minimum ON time for both the compressor

and electric heat is two minutes. Minimum on time is available only while the control is configured for Unit mounted keypad operation. Minimum on times are disabled while in Remote thermostat mode.

#### ▲▼ **LCD Back Light:**

The LCD display can be illuminated using the LCD back light feature. The selectable settings are "Off", "On", and "Intermittent" and can be set in the Configuration mode. By selecting "Off" the backlight will remain off at all times. By selecting "On" the backlight will remain on at all times including while in the Off mode interface. If "Intermittent" is selected, the backlight will remain for 10 seconds after the push of any button while the control is in the On mode or after the push of the "ON/OFF" button while in the Off mode interface.

#### ▲▼ **Drain Pan Sensor:**

The drain pan sensors monitor the condensate level in each of the units drain pans. Should the water in either pan reach a critical level, the monitor will automatically signal the main control unit. The controls microprocessor will in turn switch off the condensing unit for a minimum of three minutes and until the fault condition has been cleared, to prevent further condensate production. A fault code "E02" will then flash on the controls LCD display and will automatically reset once the fault condition is cleared.

#### ▲▼ **Annunciation:**

The unit is equipped with an annunciation feature where by the control will beep providing the user with audio feedback confirming that the microprocessor has received its commands. The annunciation feature must be activated in the Configuration mode. The selections are "Off" and "On". If "Off" is selected, annunciation will remain off. If "On" is selected then annunciation will beep with the push of any button in the On mode or with the push of the "ON/OFF" button while in the Off mode interface.



**Note:** While in Remote thermostat mode (see configuration), only the “FAN” and “TIME” buttons are activated and will beep when pressed.

**▲ Memory Backup:**

In the event of a power failure the control will retain all of it’s settings including the mode of operation. When power is restored, after a three minute time delay, the control will return to the mode of operation that it was in prior to the power failure.

**Fault Conditions**

**▲ Room air sensor fault: E01**

If the room air sensor is disconnected, damaged or malfunctions the LCD display will flash error code “E01” to signify that a fault has occurred. Operation will continue with the control using the last known value for the room air sensor.

**▲ Condensate fault: E02**

If the control senses a condensate fault condition either through the optional condensate pumps safety switch or the drain pan sensors, the LCD display will flash error code “E02”. The compressor will switch off for a minimum of three minutes and until the fault condition is corrected.

**▲ ID coil sensor fault: E03**

The indoor coil sensor monitors the temperature of the indoor coil. If a freeze condition exists continuously for three minutes, the LCD will display error code “E03” to signify that a fault has occurred. The compressor will switch off for a minimum of three minutes and until the fault condition is corrected. Also, if the micro-processor detects an evaporator freeze condition four times within a 24 hour period, the filter check indicator will appear.

**INFRARED REMOTE CONTROL OPTION**

Operational Range 55- 90° F (in 1° Increments.)

Pressing the “+” will increase the set point temperature setting. Pressing the “-” button will decrease the setpoint temperature setting.

**DRY**

Pressing the “DRY” button will place the unit in Dry Mode.

**FAN**

Pressing the “FAN” button will place the unit in fan mode.

**HEAT**

Pressing the “HEAT” button will place the unit in Heat mode.

**COOL**

Pressing the “COOL” button will place the unit in Cool mode.

**NOTE: Batteries Included.**

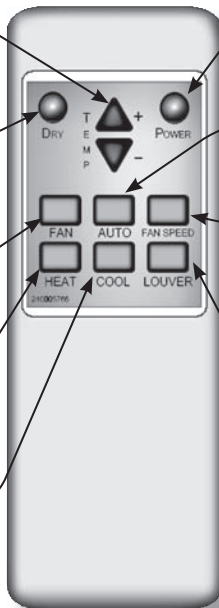

**POWER**

Pressing the “POWER” button will turn the unit On or Off.

**AUTO**

Pressing the “AUTO” button will place the unit in Auto changeover mode.

**FAN SPEED**

Pressing the “FAN SPEED” button will scroll the unit through fan the fan speed selection. The sequence is High, Low and Auto.

**LOUVER**

Pressing the “LOUVER” button will enter the Louver Configuration mode. While in Louver Configuration mode, each successive press of the louver button will scroll through the louver positions. After idle for 10 seconds, the control will exit the Louver Configuration mode.

Figure 6

## OPTIONAL HAND HELD CONTROLLER PROGRAMMING

Table #2															
PROGRAMMING SCHEDULE															
		Monday		Tuesday		Wednesday		Thursday		Friday		Saturday		Sunday	
		Time	Temp	Time	Temp	Time	Temp	Time	Temp	Time	Temp	Time	Temp	Time	Temp
Morning	Cool														
	Heat	•	■	•	■	•	■	•	■	•	■	•	■	•	■
	Auto														
Day	Cool														
	Heat	•	■	•	■	•	■	•	■	•	■	•	■	•	■
	Auto														
Evening	Cool														
	Heat	•	■	•	■	•	■	•	■	•	■	•	■	•	■
	Auto														
Night	Cool														
	Heat	•	■	•	■	•	■	•	■	•	■	•	■	•	■
	Auto														

To copy the settings from any day to the entire week:

- 1) Select the day to be copied.
- 2) Simultaneously press the “**FAN**” and “**PROG**” buttons for three seconds.

### INITIAL START-UP

Operation of the unit depends on the room temperature. It may be necessary to warm the room before testing the unit’s cooling abilities.

### WLC/WLH PREPERATION FOR START-UP

- Remove any tools or other obstructions
- Be sure the filter is in place
- Verify that the unit is level
- Separate any lines that contact each other
- Replace the cabinet end cap and the grille front of the unit

*Start-Up and the Operating Instructions in Control Operation Section, Thermostat, Unit Mount or Remote.)*

**Note: Check the outdoor unit’s start-up instructions for specific requirements and procedures.**

Test each power and circuit connection before powering up the system. Use the unit mounted electronic thermostat controls to start the system. (Refer to the *Initial*

## TEST UNIT PERFORMANCE DATA SHEET

The Test Unit Performance Data sheet below is provided for use by a qualified service professional in the event that there is a problem with the unit. In order for our Technical Service Department to better serve you, please complete and have

this information ready when calling. Make sure to include the Model Number, Serial Number, Date of Installation.  
 Call our Technical Support Department @ 1-800-228-9364.

Test Unit Performance Data	
	Date:
Model Number	Technician:
Serial Number	Mode: Cooling
Indoor Section	Notes
Evaporator Entering Air - DB	
Evaporator Entering Air - WB	
Evaporator Leaving Air - DB	
Evaporator Leaving Air - WB	
Outdoor Section	
Entering Air	
Leaving Air	
Temperature Split	
Operating Pressures	
Compressor Suction - PSIG	
Compressor Discharge - PSIG	
Power Input	
Compressor - Volts	
Compressor - Amps	
OD Fan Motor - Volts	
OD Fan Motor - Amps	
ID Fan Motor - Volts	
ID Fan Motor - Amps	
Total Volts	
Total Amps	
Temperatures - Degrees F°	
Compressor Suction	
Compressor Discharge	
Liquid Out Cond.	
Liquid before Expansion	
Suction out Evaporator	
Capacity Calculations	
DB - Temp Split at evap.	
Test Summary	
Compressor Superheat	
Sub Cooling	

## MAINTENANCE

### WARNING

Turn the **POWER OFF** to the unit before servicing or cleaning.

Service should be performed by a **qualified** service agency and an annual system check is recommended. EMI units are designed and constructed for reliability and long life with minimal maintenance. To insure peak operating efficiency:

1. Clean air filter on a monthly basis or when it is visibly dirty\*:
  - a) The filter is accessed by removing the front air intake access grille:
    - Lift and remove grille

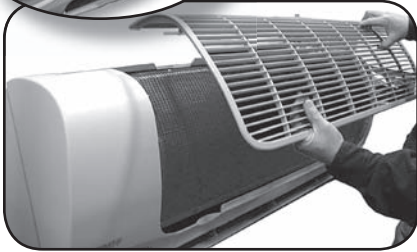

2. To clean the filter pull open the 2 clips at the base of the filter and carefully pull the filter out. Place the filter on a flat surface.

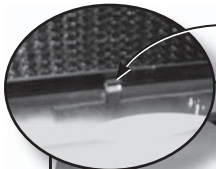

Close-up of filter clip



- a) To vacuum: Use a brush attachment and vacuum all visible dirt.

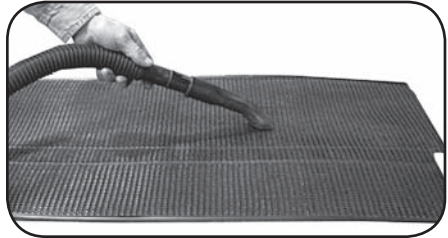

- b) Or use a garden hose: Follow steps 1 and 2 then hose filter off. Let filter dry before replacing.

***\*Allowing dust to collect on the filter will result in reduction of air flow and cause the unit to lose efficiency. This condition will cause the unit to malfunction.***

3. Replace filters and grille before running unit.

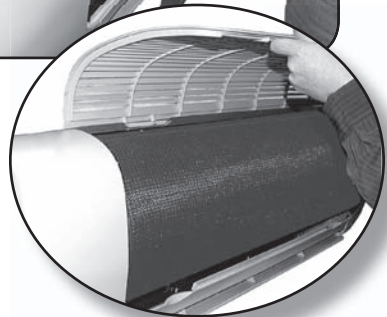

## MAINTENANCE AND TROUBLESHOOTING PROCEDURE

### MAINTENANCE

4. Vacuum dust from the return air grille and coil surface when cleaning the filter.
5. The unit may be wiped with a damp cloth when needed.



**Note:** Do not run the unit without the filter or the grille.

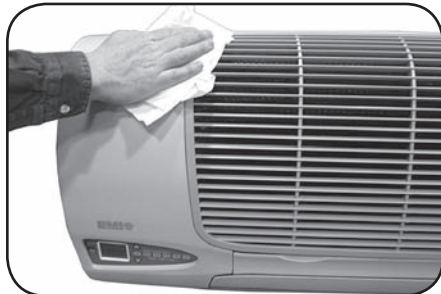

### TROUBLESHOOTING

#### EMI Air Handlers With Unit Mount Infrared Controls

#### WARNING

*All service should be performed by a qualified service technician. Before removing access panels or control covers to expose moving parts of non-insulated live electrical components for service, disconnect all high Volt power supplies to both the indoor unit and outdoor unit. Failure to do so could result in physical injury and/or electrical shock.*

When trouble-shooting the indoor unit, please refer to the wiring diagram that is supplied with the equipment. It is located either on the back of the removable return air grill. If you are unable to locate the wiring diagram please feel free to call the factory technical service line at (800) 228-9364 and one can be faxed or mailed. Please have the full model and serial number available prior to calling.

EMI **America Series** evaporators are designed to operate with EMI **America Series** condensers. The evaporator (indoor unit) and condenser (outdoor unit) are to be independently connected to the electrical service panel and protected by separate

time delay fuse or HACR breakers. (See the unit name plate for the correct breaker type and size). The indoor and outdoor units are also connected to each other via a 24V interconnect wiring. A transformer provides the low Volt power source for the controls. The number of low Volt interconnect conductors will be two to six depending on heating options and thermostat selection. Interconnect wire should be at least 18 awg. Refer to the unit wiring diagram for the interconnect diagram that matches your system.

**Figure 1A**

#### Unit mount control configuration Straight Cool Application

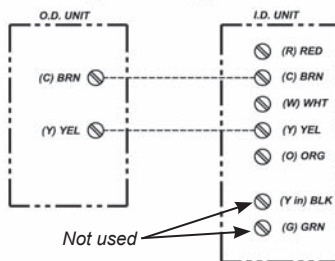

**Figure 1B**

**Unit mount control configuration  
Heat Pump Application**

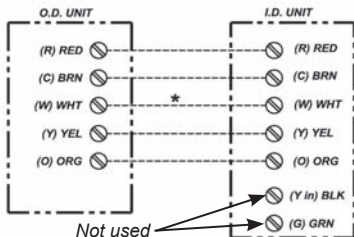

\* Electric heat option

**Figure 2 C**

**Remote wall mounted thermostat configuration  
Heat Pump Application**

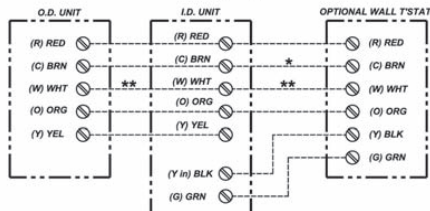

\* Some thermostats do not use a "C" terminal

\*\* Electric heat option

**Figure 2 A**

**Remote wall mounted thermostat configuration  
Straight Cool Application**

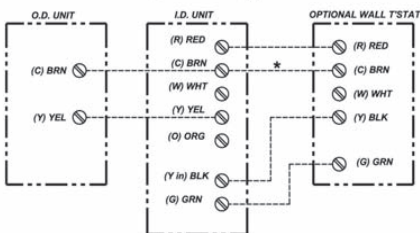

\* Some thermostats do not use a "C" terminal

**Figure 2 B**

**Remote wall mounted thermostat configuration  
Cooling/Electric Heat Application**

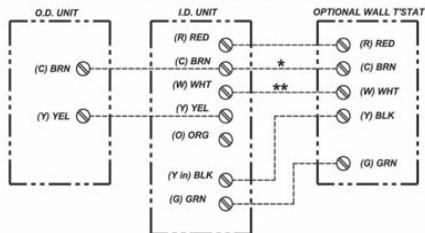

\* Some thermostats do not use a "C" terminal

\*\* Electric heat option

**Power Supply Check**

When trouble shooting any EMI product, it is important to first check the rating plate for proper field voltage and breaker size. Secondly using a voltmeter check the incoming power supply to see that it agrees with the rating plate. The incoming power should not exceed the nameplate voltage. Also, the incoming power should not be below the minimum voltage stated on the rating plate (197V for units rated 208/230V and 104V for units rated 115V).

A check for low voltage power should also be made. By placing a voltmeter across low Volt terminals "R" and "C" at the indoor unit, there should be a reading of 24V.

**▲ Test Mode** is available for unit mounted control configuration only. Use of test mode can aid in the functional check of the unit. It can also be a helpful tool when trouble shooting to solve a problem.

To enter test mode, while the unit is in off mode, press "On/Off", "PROG" AND "Time" buttons simultaneously for three seconds. To exit press again or remove power to the unit. While in test mode all timers are shortened.

**CAUTION**

While in test mode, all timers are eliminated. Avoid short cycling the compressor. After system checks are complete, the control must be returned to normal operation. **DO NOT LEAVE THE SYSTEM IN TEST MODE!**

**LOW VOLT CONTROLS**

**Cooling Only Units**

Cooling only units utilize low Volt interconnecting wires between the indoor unit, outdoor units and thermostat. For air handlers with unit mounted controls, wires (WLC/WLH) designated "Y" (yellow) and "C" (brown) of the indoor air handler should be connected to the corresponding "Y" (yellow) and "C" (brown) wires or terminals of the outdoor condenser. Other wires or terminals such as "R" (red) or "O" (orange) may not be needed and should be protect by a wire nut from making contact with the junction box or other metal surfaces.

Refer to low Volt interconnect diagram interconnect diagram **Figure 1** for unit mounted controls and **Figure 2** for remote thermostat connection.

A 24V transformer located in the indoor air handler unit provides low Volt control power to both the indoor air handler and outdoor condenser. The 24V power supply can be measured by placing a meter across the "R" and "C" low Volt terminals of the air handler. The air handler will switch on and off the condenser through the yellow (Y) wire. When the air handler is calling for cooling, 24V can be measured between terminals (wires) Y and C.

**Electric Heat**

Units with electric heat utilize a control relay located on the circuit board in the control box. As a safety feature, an auto resetting limit switch located on the heater

end plate or on the heater assembly will interrupt power to the heater should an over-heat condition occur. Each electric heat assembly is also equipped with a one time fuse link (if triggered a new fuse link is required). Should electric heat temperatures rise above the auto resetting limit switch, a non-resetting, one time fuse link will open and the heater will remain off.

The following current values apply when the unit is connected to a 230V power supply. These values include fan motor current. If the supply power is different, this will in turn affect the amp draw of the heater.

5kW = 22.3 amps, 4kW = 18 amps,  
3kW = 13.5 amps.

**Optional Heat Pump with Electric Heat**

Heat pump units with electric heat utilize four to six interconnecting, **low Volt** wires depending control setup and/or thermostat selected. Refer to the low Volt interconnect section and **Figures 1 & 2** for your particular unit. A 24V transformer located in the indoor air handler provides low Volt control power to both the air handler and condenser. With high Volt power supplied to the condenser, 24V can be measured across the red (R) and brown (C) wires at all times.

**▲ Cooling:** The air handler will cycle the condenser on and off through the yellow (Y) wire. To check for a condenser signal, select cooling mode on the indoor unit or thermostat and place the set-point temperature below room temperature. Then, with a voltmeter check for 24 Volts across the yellow (Y) and brown (C) wires. If no signal is found then re-check all wiring connections to ensure that they match the low Volt interconnect diagram. Check the output of the 24V transformer (located in the air handler) to ensure that the control voltage is present.

### Optional Heat Pump with Electric Heat *Continued*

EMI heat pump systems utilize a reversing valve is that is energized in the cooling mode. The reversing-valve signal is provided through the orange (O) low Volt wire of the air handler or thermostat. It should remain energized constantly as long as the indoor unit or thermostat remains in cooling mode. To check for 24V reversing valve voltage, at the outdoor unit, place a voltmeter across the brown (C) and orange (O) wires while in the cooling mode.

▲ **Heating:** Heat pump units can accommodate two-stage heating when an optional electric strip heater is present along with a heat pump condenser. The first stage being the compressor and the second is electric heat. The air handler or wall thermostat will cycle the condenser through the yellow (Y) wire as it does in cooling however the reversing valve will not be energized. To check for a condenser signal, place the indoor unit or wall thermostat in heating. Next place the set-point temperature one degree above room temperature to call the first stage of heating. Then, with a voltmeter check for 24 Volts across the yellow (Y) and brown (C) wires at the condenser. The electric heat should be off at this point. Select a set-point temperature that is more than two degrees above the room temperature to call for the second stage of heating. The electric heat should energize along with the 24V compressor signal between “Y” and “C”. Check to see that the amp draw corresponds with the electric heat rating.

The following current values apply when the unit is connected to a 230V power supply. These values include indoor fan motor current. If the supply power is different, this will affect the amp draw of the heater.

5kW = 22.3 amps, 4kW = 18 amps,  
3kW = 13.5 amps.

Units with electric heat utilize a control relay located on the circuit board in the control box. As a safety feature, an auto resetting limit switch located on the heater end plate or on the heater assembly will interrupt power to the heater should an over-heat condition occur. Each electric heat assembly is also equipped with a one time fuse link. Should electric heat temperatures rise above the auto resetting limit switch, a non-resetting, one time fuse link will open and the heater will remain off (to restart a new fuse link is required).

### Units With Condensation Pumps

EMI Air Handlers are available with an optional condensate pump. Condensate pumps are recommended when it is not possible to gravity drain the condensation from the indoor unit. Depending on the pump manufacture the maximum lift for the pump will vary. Consult the pump instructions for the maximum lift for the particular pump being used.

Condensation generated by the evaporator will collect in the pumps' reservoir. When the water level is high enough, a float switch will close and energize the pump motor clearing the water from the reservoir. Should for any reason the water exceed the maximum preset level, a safety switch will open, there by interrupting the (Y) signal to the condenser. This will prevent the evaporator from generating more condensation and spilling out of the unit.



## Frequently Asked Questions

- Q:** The system has just been installed using an EMI indoor unit and a non-EMI condenser. There is no display and the unit will not operate.
- A:** EMI air handlers are manufactured with a low Volt transformer installed. When connecting an EMI evaporator to a non-EMI condenser, check to ensure that there is no 24V control transformer in the outdoor unit. Only one transformer is required. If both the indoor unit and outdoor unit contain a transformer, one must be removed from the system.
- Q:** The condenser will not start although the indoor unit appears normal. What should I do?
- A:** At the indoor unit, make sure that the control is in cooling and the setpoint temperature is below room temperature. Next, using a volt meter, check for 24V across the yellow (Y) and brown (C) wires. If 24V is present then check for wiring breaks or improper connections between the indoor and outdoor units.
- A:** Some EMI condensers are equipped with a manual reset high-pressure switch. It is located on the high side of the refrigerant system usually on the discharge line of the compressor. To reset, simply push the red button in. If the switch was tripped there will be a "click" when it resets.
- A:** If the unit is equipped with a condensate pump check to see if the safety float has been tripped. This can be done by first disconnecting both ends of the float switch. Then with an Ohmmeter, check for continuity across the switch. If the switch is open then the pump is not clearing or the switch may be bad.
- Q:** The display on the indoor unit is blank. What should I do?
- A:** Check the power supply (see "Power supply check" Section). If the unit still fails to turn on via the **On/off** button then inspect the control box for any apparent wires that may have come loose during shipping. Also inspect the circuit boards for burnt components. If no obvious problem can be found then replace all circuit boards including the unit keypad. Do not attempt to trouble shoot the individual circuit boards.
- Q:** The display tends to flicker at times. Is this normal?
- A:** A small amount of flickering of the display is normal. Depending on the room lighting, flickering may be noticeable at some times more than others.
- Q:** How long will the fan run?
- A:** While the unit is in cooling or heating and auto fan mode is selected, Fan speed will be determined by the micro-processor and speed adjustment will be made according to room and setpoint temperatures. The fan will switch to **High** speed when room temperature deviates by more than two degrees from setpoint. The fan will switch to **Low** speed if the deviation is one degree. When the room temperature reaches setpoint temperature the heat/cool call is dropped. The fan will then stay on for an additional 60 seconds to purge unit of any residual energy. If **High** or **Low** is selected then the fan will operate continuous regardless of set point or room temperatures.
- Q:** What causes my indoor unit to freeze-up?
- A:** Evaporator freeze up is usually the symptom of another problem. Units with infrared compatible, unit mounted controls are equipped with freeze protection

**Frequently Asked Questions *Continued***

to prevent freeze up from occurring. If freeze up does occur then check the following.

- Check that the freeze sensor located in the lowest part of the coil. Generally this is where freeze up will begin.
- Check that the freeze sensor inserted fully and snug in the coil fin. If not another location may need to be selected. Be careful not to insert the sensor directly into the coil tube rather insert the sensor between two tubes.
- Check the indoor air filter. It should be clean and free of dirt. A dirty filter will reduce airflow and efficiency. Also check that the coil is clean. If the coil is dirty then it should be cleaned using an appropriate coil cleaner or mild detergent.
- Is the equipment being operated in cooling mode when outdoor temperatures are below 60°F? If it is, then the condenser should be fitted with low ambient control so that the proper system pressures are maintained.
- Does the system have the proper refrigerant charge? A system low on refrigerant can cause evaporator freeze-up. To check system charge you will need to contact a qualified refrigeration service technician. Refrigerant charge information can be found in IOM for the outdoor condensing unit.

## WLC/WLH HIGH WALL EVAPORATOR SPECIFICATIONS AND DIMENSIONS

**NOTE:** Due to EMI's ongoing development programs, design and specifications may change without notice.

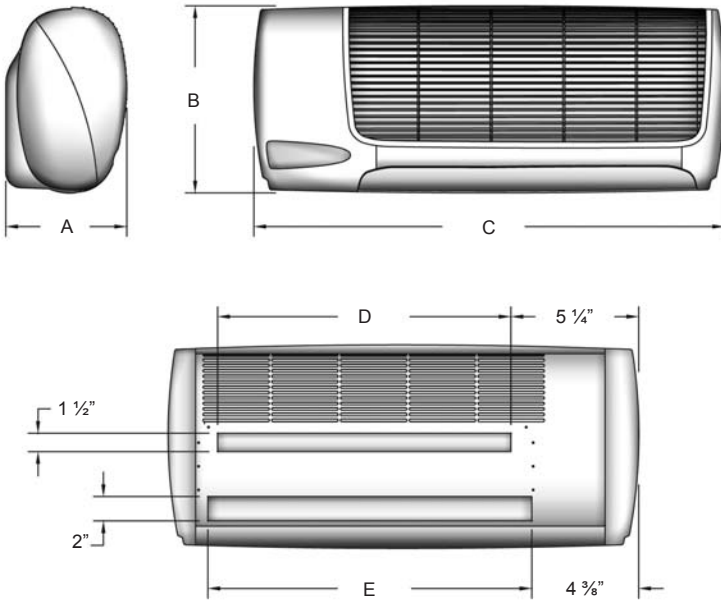

### WLC/WLH PHYSICAL DIMENSIONS

Model	"A" Depth	"B" Height	"C" Length	"D" Mounting Bracket Clearance	"E" Tubing Access Clearance
WLHA09	9 7/8"	15 1/4"	38 1/2"	24"	26 1/2"
WLHA12	9 7/8"	15 1/4"	38 1/2"	24"	26 1/2"
WLHA24	9 7/8"	15 1/4"	48 1/2"	34"	36 1/2"
WLCA30	9 7/8"	15 1/4"	58 1/2"	44"	46 1/2"
WLCA36	9 7/8"	15 1/4"	58 1/2"	44"	46 1/2"

### WLC/WLH SHIPPING WEIGHT

Model	Lbs.
WLHA09	58.00
WLHA12	60.25
WLHA24	66.20
WLCA30	90.10
WLCA36	91.10

### WLC/WLH OBSERVED SOUND VALUES \* (230V High Speed Fan)

Model	dBA
09/12	45
18/24	56
30/36	60

# WLC/WLH HIGH WALL EVAPORATOR SPECIFICATIONS

## WLC/WLH ELECTRICAL SPECIFICATIONS

MODEL #	VOLTS/HZ/PH	FAN RLA	HP	HEATER K.W.	AMPS	TOTAL AMPS	MIN VOLT	M.C.A.	HACR BRKR
<b>SMALL CABINET 09/12</b>									
09/12	115/60/1	0.64	0.02	–	–	0.64	104	0.8	15
	115/60/1	0.64	0.02	0.75	6.50	7.14	104	8.9	15
	208/230/60/1	0.34	0.02	–	–	0.34	197	0.4	15
	208/230/60/1	0.34	0.02	3.00	13.04	13.38	197	16.7	20
<b>MEDIUM CABINET 18/24</b>									
24	115/60/1	1.20	0.083	–	–	1.20	104	1.5	15
	115/60/1	1.20	0.083	0.75	6.52	7.72	104	9.7	15
	115/60/1	1.20	0.083	1.25	10.90	12.10	104	15.1	20
	208/230/60/1	0.56	0.070	–	–	0.56	197	0.7	15
	208/230/60/1	0.56	0.070	3.00	13.04	13.60	197	17.0	20
	208/230/60/1	0.56	0.070	5.00	21.74	22.30	197	27.9	30
<b>LARGE CABINET 30/36</b>									
30/36	208/230/60/1	0.80	1/10	–	–	0.80	197	1.0	15
	208/230/60/1	0.80	1/10	5.00	21.74	22.54	197	28.2	30

DISCHARGE AIR SPEED AND FLOW @ 230V					
Model	High CFM	Low CFM	Coil	FPM	Throw/ Ft.
09/12	400	350	Dry	900	15
18/24	750	675	Dry	1,225	25
30/36	1,100	900	Dry	1,250	27

WLC/WLH INTERCONNECTING-LINE SIZE			
System Capacity Btuh	Liquid O.D.	Suction O.D.	Condensate I.D.
09	1/4"	1/2"	1/2"
12	1/4"	1/2"	1/2"
18	3/8"	5/8" *	1/2"
24	3/8"	3/4"	1/2"
30	3/8"	3/4" **	1/2"
36	3/8"	3/4" **	1/2"

\* WLC/WLH Suction Connection size is 3/4" O.D. and must bush down at the WLC/WLH Unit.

\*\* WLC Suction Connection size is 5/8" O.D. a factory supplied kit is provided to transition to 3/4" O.D. interconnect.



**ARI Standard**  
210/240 UAC



**ARI Standard**  
210/240 UHP



## WLC/WLH SYSTEM OPTIONS

**NOTE:** Due to EMI's ongoing development programs, design and specifications may change without notice.

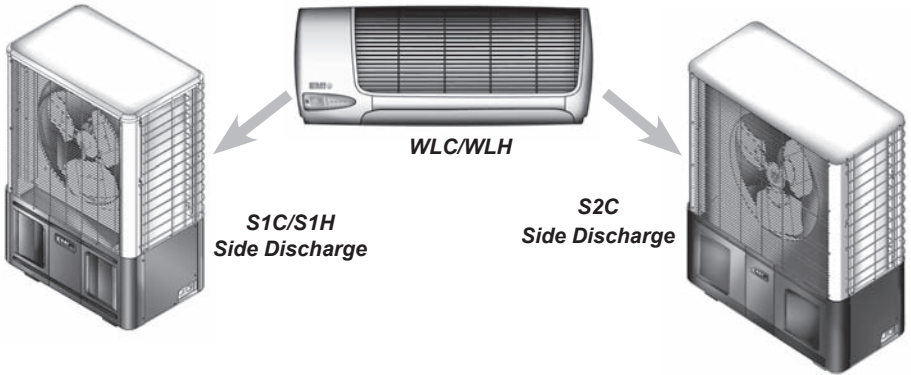

### COOLING SYSTEMS WITH WALL UNITS

Condenser	Wall Unit	Btuh	SEER	SHR	EER	Ref.
S1CA9	WLHA09	9,000	13.0	.79	11.8	R22
S1CA2	WLHA12	12,000	14.0	.74	12.9	R22
S1CA8	WLHA24	18,000	14.0	.78	13.0	R22
S1CA4	WLHA24	24,000	13.0	.70	12.5	R22
S1CA3	WLCA36	30,000	13.0	.72	12.6	R22
S1CA6	WLCA36	33,600	13.0	.69	12.1	R22

### HEAT PUMPS SYSTEM OPTIONS WITH WALL UNITS

Condenser	Wall Unit	Cooling Btuh	Heating Btuh	SEER	HSPF	SHR	EER	COP	Ref.
S1HA9	WLHA09	9,000	8,200	13.0	7.7	.75	12.0	3.6	R22
S1HA2	WLHA12	12,000	10,200	13.0	7.7	.73	12.1	3.4	R22
S1HA8	WLHA24	18,000	16,400	13.0	7.7	.73	12.1	3.8	R22
S1HA4	WLHA24	23,000	20,600	13.0	7.7	.71	11.9	3.5	R22

### COOLING SYSTEMS WITH S2C SIDE DISCHARGE

Wall Unit (s)	Condenser	Btuh	SEER	SHR	EER	Ref.
WLHA09	S2CA99	18,000	13	.80	11.9	R22
WLHA12	S2CA22	23,000	13	.72	12.4	R22
WLHA09+WLHA12	S2CA92	21,000	13	.72	12.0	R22

## WLC/WLH SYSTEM OPTIONS Continued

**NOTE:** Due to EMI's ongoing development programs, design and specifications may change without notice.



**WLC**

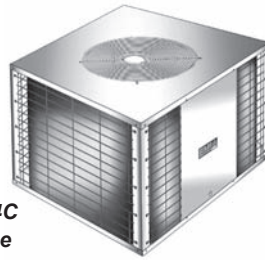

**T2C, T3C & T4C  
Top Discharge**

### SYSTEM OPTIONS WITH T2C TOP DISCHARGE

Wall Unit(s)	Condenser	Btuh	SEER	SHR	EER	Ref.
WLHA24	T2CA88	36,000	13	.79	12.1	R22
WLHA24	T2CA44	45,000	13	.73	11.8	R22
WLHA09+WLHA24	T2CA98	27,000	13	.80	11.8	R22
WLHA24	T2CA84	41,000	13	.76	11.8	R22
WLHA12+WLHA24	T2CA24	34,000	13	.72	11.8	R22

### SYSTEM OPTIONS WITH T3C TOP DISCHARGE

Wall Unit(s)	Condenser	Btuh	SEER	SHR	EER	Ref.
WLHA09+WLHA24	T3CA994	41,000	13	.77	11.9	R22
WLHA09	T3CA999	27,000	13	.80	11.7	R22
WLHA12	T3CA222	34,000	13	.71	11.7	R22
WLH09A+WLHA24	T3CA928	39,000	13	.77	11.9	R22
WLHA09+WLHA12+WLHA24	T3CA924	43,000	13	.75	11.8	R22
WLHA12+WLHA24	T3CA228	41,000	13	.74	11.8	R22
WLHA09+WLHA12	T3CA922	32,000	13	.74	11.8	R22
WLHA09+WLHA12	T3CA992	30,000	13	.77	11.9	R22
WLHA09+WLHA24	T3CA998	36,000	13	.80	11.8	R22
WLHA12+WLHA24	T3CA224	46,000	13	.72	11.7	R22

### SYSTEM OPTIONS WITH T4C TOP DISCHARGE

Wall Unit(s)	Condenser	Btuh	SEER	SHR	EER	Ref.
WLHA09	T4CA9999	36,000	13	.80	11.8	R22
WLHA12	T4CA2222	45,000	13	.73	11.7	R22
WLHA09+WLHA12	T4CA9222	42,000	13	.71	11.8	R22
WLHA09+WLHA12	T4CA9992	38,000	13	.71	11.8	R22
WLHA09+WLHA12	T4CA9922	41,000	13	.73	11.9	R22

## ALL PRODUCT LIMITED WARRANTY

Enviromaster International LLC (EMI) warrants to the purchaser/owner that EMI products will be free from defects in material and workmanship under the normal use and maintenance for a period of twelve months for all components and sixty months on unit compressors from the date of original installation, or fifteen months for all components and sixty-three months on unit compressors from the date of manufacture, whichever comes first.

### WHAT WE WILL COVER

EMI will replace any defective part returned to EMI's approved service organization with a new or rebuilt part at no charge. The replacement part assumes that unused portion of this warranty.

### WHAT WE DON'T COVER

**THIS WARRANTY DOES NOT INCLUDE LABOR** or other costs incurred for repairing, removing, installing, shipping, servicing, or handling of either defective or replacement parts.

### EMI IS NOT RESPONSIBLE FOR:

- Normal maintenance
- Damage or repairs required as a consequence of faulty installation or application by others.
- Failure to start due to voltage conditions, blown fuses, open circuit breakers, or other damages due to the inadequacy or interruption of electrical service.
- Damage or repairs needed as a consequence of any misapplication, abuse, improper servicing, unauthorized alteration, or improper operation.
- Damage as a result of floods, winds, fires, lightening, accidents, corrosive atmosphere, or other conditions beyond the control of EMI.
- Parts not supplied or designated by EMI.
- Products installed outside the United States or Canada.
- Any damages to person or property of whatever kind, direct or indirect, special or consequential, Whether resulting from use or loss of use of the product.

### LIMITATION OF WARRANTIES

This warranty is exclusive and in lieu of any implied warranties of merchantability and fitness for a particular purpose and all other warranties express or implied. The remedies provided for in this warranty are exclusive and shall constitute the only liabilities on the part of EMI including any statements made by any individual which shall be of no effect.

### FOR SERVICE OR REPAIR:

- (1) Contact the Installer
- (2) Call the nearest Distributor
- (3) Call or write:



**Enviromaster International LLC**  
5780 Success Drive, Rome, NY 13440  
[www.enviromaster.com](http://www.enviromaster.com)

**EMI'S HIGH EFFICIENCY PRODUCT LINE**

**EVAPORATORS**

**WLC/WLH**  
**High Wall Evaporator**



**CAC**  
**Cassette Evaporator**



**CONDENSERS**

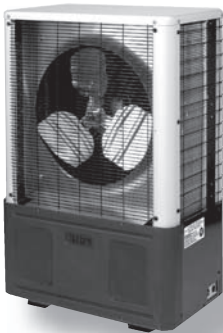

**S1C & S1H Single Zone**  
**Side Discharge**

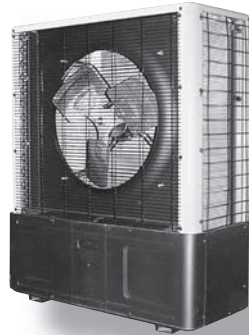

**S2C Dual Zone**  
**Side Discharge**



**T2C, T3C & T4C 2, 3 & 4 Zone**  
**Top Discharge**