

# ENVIROair

## FSR Series

### 15 SEER Inverter Single-Zone Ductless Split Systems

Air Handler (Indoor) Models - FWCA  
Condenser (Outdoor) Models - FCA

### Installation, Operation and Maintenance Manual

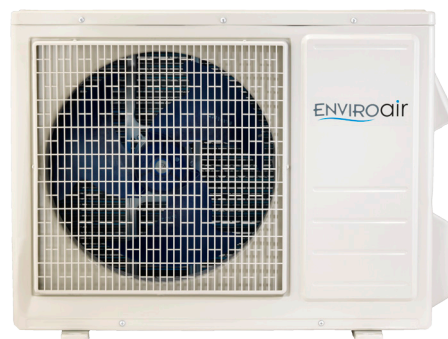

**EMI**  *Ductless*  
*Comfort Where It Counts.*



An ISO 9001-2008 Certified Company

**ECR International, Inc.**  
2201 Dwyer Avenue,  
Utica NY 13501  
web site: [www.ecrinternational.com](http://www.ecrinternational.com)

P/N 240009906, Rev B [04/05/2013]

# **CONTENTS**

<b>INSTALLATION PRECAUTIONS</b> .....	<b>2</b>
<b>SAFETY PRECAUTIONS</b> .....	<b>2</b>
<b>SELECT THE BEST LOCATION</b> .....	<b>3</b>
<b>INDOOR UNIT</b>	
INSTALLATION PLATE MOUNTING .....	<b>4</b>
DRILL A HOLE IN THE WALL .....	<b>4</b>
CONNECT THE CABLE TO THE INDOOR UNIT .....	<b>5</b>
CONNECTIVE PIPE AND DRAINAGE INSTALLATION .....	<b>5</b>
<b>OUTDOOR UNIT</b>	
OUTDOOR INSTALLATION PRECAUTION .....	<b>7</b>
DRAIN JOINT INSTALLATION .....	<b>7</b>
REFRIGERANT PIPE CONNECTION .....	<b>7</b>
CONNECT THE CABLE TO THE OUTDOOR UNIT .....	<b>8</b>
AIR PURGING AND TEST OPERATION .....	<b>8</b>
<b>SOCIABLE REMARK</b>	
Sociable remark.....	<b>11</b>
<b>SAFETY PRECAUTIONS</b>	
Warning .....	<b>12</b>
Caution .....	<b>13</b>
<b>OPERATING INSTRUCTIONS</b>	
Parts names .....	<b>14</b>
Special functions .....	<b>15</b>
Operating temperature.....	<b>16</b>
Manual operation .....	<b>16</b>
Airflow direction control .....	<b>17</b>
How the air conditioner works .....	<b>18</b>
<b>CARE AND MAINTENANCE</b>	
Care and maintenance .....	<b>20</b>
<b>OPERATION TIPS</b>	
Operation tips .....	<b>22</b>
<b>TROUBLESHOOTING TIPS</b>	
Troubleshooting tips .....	<b>23</b>

# INSTALLATION MANUAL FOR ROOM AIR CONDITIONER

## (Split Wall-Mounted Type)

### **INSTALLATION PRECAUTIONS**

- Please read this installation manual carefully before operating the unit to ensure correct installation.
- If the power cord is damaged, replacement work shall be performed by authorised personnel only.
- Installation work must be performed in accordance with the national wiring standards by authorised personnel only.
- Contact an authorized service technician for repair, maintenance and installation of this unit.
- This appliance is not intended for use by persons (including children) with reduced physical, sensory or mental capabilities, or lack of experience and knowledge, unless they have been given supervision or instruction concerning use of the appliance by persons responsible for their safety.
- Children should be supervised to ensure that they do not play with the appliance.
- All the pictures in the instructions are for explanation purposes only. The actual shape should prevail.
- The design and specifications are subject to change without prior notice for product improvement. Consult with the sales agency or manufacturer for details.

### **SAFETY PRECAUTIONS**

- Please read these safety precautions carefully before installation
- Be sure to follow all the precautions below, they are all important for ensuring safety.



**WARNING**

This symbol indicates the possibility of death or serious injury.



**CAUTION**

This symbol indicates the possibility of injury or damage to property.



**WARNING**

- 1) Install according to this installation instructions strictly. If installation is defective, it will cause water leakage, electrical shock, or fire.
- 2) Use the included accessories parts and specified parts for installation. otherwise, it will cause the set to fall, water leakage, electrical shock fire.
- 3) Install at a strong and firm location which is able to withstand the set's weight. If the strength is not enough or installation is not properly done, the set will drop and cause injury.
- 4) For electrical work, follow the local national wiring standard, regulation and this installation instructions. An independent circuit and single outlet must be used. If electrical circuit capacity is not enough or defect found in electrical work, it will cause electrical shock fire.
- 5) Use the specified cable and connect tightly and clamp the cable so that no external force will be acted on the terminal. If connection or fixing is not perfect, it will cause heat-up or fire at the connection.
- 6) Wiring routing must be properly arranged so that control board cover is fixed properly. If control board cover is not fixed perfectly, it will overheat at connection point of terminal, fire or electrical shock.
- 7) When carrying out piping connection, take care not to let air substances other than the specified refrigerant go into refrigeration cycle. Otherwise, it will cause lower capacity, abnormal high pressure in the refrigeration cycle, explosion and injury.
- 8) Do not modify the length of the power supply cord or use of extension cord, and do not share the single outlet with other electrical appliances. Otherwise, it will cause fire or electrical shock.



**CAUTION**

- 1) This equipment must be grounded and installed with ground leakage current breaker. It may cause electrical shock if grounding is not perfect.
- 2) Do not install the unit at place where leakage of flammable gas may occur. In case gas leaks and accumulates at surrounding of the unit, it may cause fire.
- 3) Carry out drainage piping as mentioned in installation instructions. If drainage is not perfect, water may enter the room and damage the furniture.

# SELECT THE BEST LOCATION

## Indoor unit

- There should not be any heat source or stream near the unit.
- There should not be any obstacles blocking the air circulation.
- A place where air circulation in the room is good.
- A place where drainage can be easily done.
- A place where noise prevention is taken into consideration.
- Do not install the unit near the door way.
- Ensure the spaces indicated by arrows from the wall, ceiling, fence or other obstacles.
- There should not be any direct sunlight. If unavoidable, sunlight prevention should be taken into consideration.

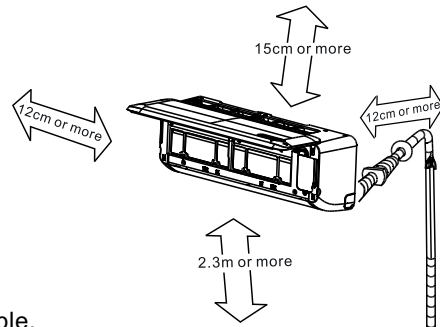

## Outdoor unit

- If an awning is built over the unit to prevent direct sunlight or rain, be careful that heat radiation from the condenser is not obstructed.
- There should not be any animal or plant which could be affected by hot air discharged.
- Keep the spaces indicated by arrow from wall ceiling, fence or other obstacles.
- Do not place any obstacles which may cause a short circuit of the discharged air.

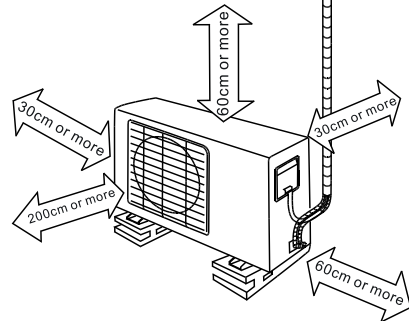

## Settlement of outdoor unit

- Anchor the outdoor unit with a bolt and nut  $\phi 10$  or  $\phi 8$  tightly and horizontally on a concrete or rigid mount.  
**NOTE:** The outdoor unit you purchase may be like one of the following. Install the outdoor unit according to the dimension as indicated in the table below:

Outdoor unit dimension mm(WxHxD)	Mounting dimensions	
	A(mm)	B(mm)
700x540x240	458	250
685x430x260	460	276
780x540x250	549	276
760x590x285	530	290
845x700x320	560	335
775x545x310	600	320
660x540x265	481	276

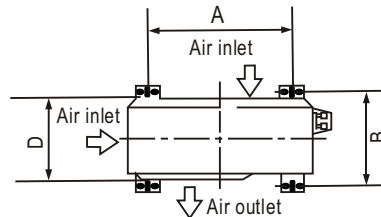
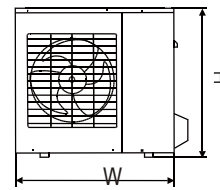

## ACCESSORIES

Number	Name of Accessories		Qty	
1	Installation Plate		1	
2	Clip Anchor		5-8 (depending on models)	
3	Self-tapping Screw A ST3.9x25		5-8 (depending on models)	
4	Seal (For cooling & heating models only)		1	
5	Drain Joint (For cooling & heating models only)		1	
6	Connecting pipe Assembly	Liquid side	Parts you must purchase. The pipe size differ from appliance to appliance. Consult the technician for the proper size.	
				$\phi 6.35$
				$\phi 9.52$
		Gas side		$\phi 9.52$
			$\phi 12.7$	
			$\phi 16$	
7	Remote controller		1	
8	Self-tapping Screw B ST2.9x10	optional parts	2	
9	Remote controller holder		1	
10	Air freshening filter (installed on Air filter)		1	

**NOTE:** Except the above parts provided, the other parts needed during installation you must purchase.

# INDOOR UNIT

## 1 INSTALLATION PLATE MOUNTING

**NOTE:**

The mounting wall is strong and solid enough to prevent it from the vibration.

● **Installation Plate Mounting**

1. Fit the installation plate horizontally on structural parts of the wall with spaces around the installation plate.
2. If the wall is made of brick, concrete or the like, drill five or eight 5mm diameter holes in the wall. Insert Clip anchor for appropriate mounting screws.
3. Fit the installation plate on the wall with five or eight type "A" screws.

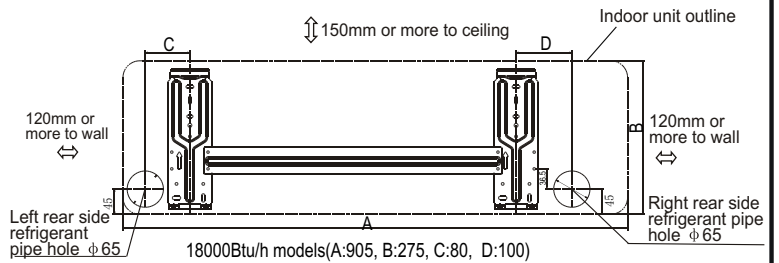
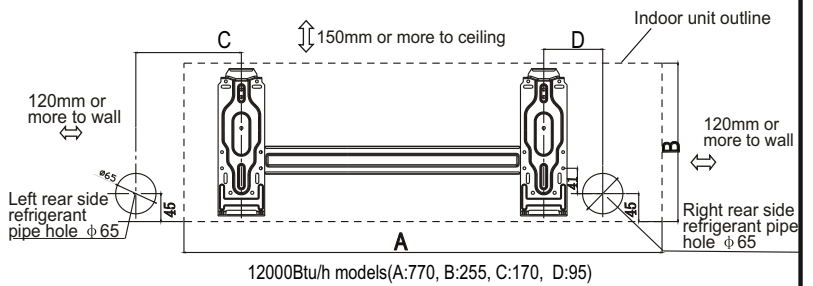
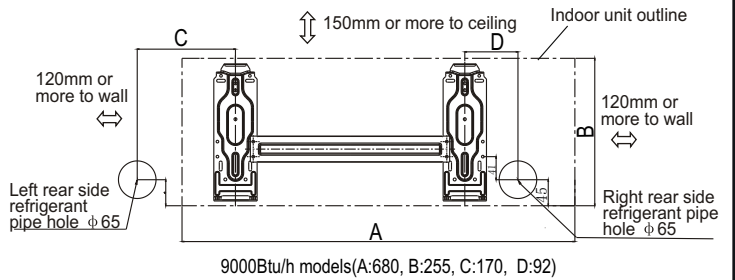

**NOTE:**

Mount the Installation Plate and drill holes in the wall according to the wall structure and corresponding mounting points on the installation plate. The installation plate provided with the machine differ from appliance to appliance.

(Dimensions are in " mm " unless otherwise stated)

Correct orientation of Installation Plate

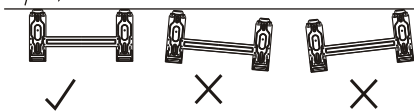

## 2 DRILL A HOLE IN THE WALL

1. Determine hole positions according to left and right side of the installation plate. The hole center is obtained by measuring the distance as shown in the diagram above.
2. Drill the piping plate hole with  $\phi 65$ mm hole-core drill.
3. Drill the piping hole at either the right or the left and the hole should be slightly slanted to the outdoor side.
4. Always take steps to protect the pipe when drilling metal grid, metal plate or the like.

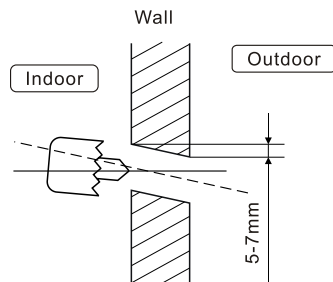

### 3 CONNECT THE CABLE TO THE INDOOR UNIT

#### Electricalwork

Electric safety regulations for the initial Installation

1. If there is serious safety problem about the power supply, the technicians should refuse to install the air conditioner and explain to the client until the problem is solved.
2. Power voltage should be in the range of 90%~110%of rated voltage.
3. The surge protector and main power switch with a 1.5 times capacity of Max. Current of the unit should be installed in power circuit.
4. Ensure the air conditioner is grounded well.
5. According to the attached Electrical Connection Diagram located on the panel of the outdoor unit to connect the wire.
6. All wiring must comply with local and national electrical codes and be installed by qualified and skilled electricians.
7. An all-pole disconnection device which has at least 3mm separation distance in all pole and a residual current device(RCD) with the rating of not exceeding 30mA shall be incorporated in the fixed wiring according to the national rule.
8. An individual branch circuit and single receptacle used only for this air conditioner must be available. See the following table for suggested wire sizes and fuse specifications:

**Suggest Minimum Wire Size**  
(AWG:American Wire Gage):

Appliance Amps	AWG Wire Size
10	18
13	16
18	14
25	12
30	10

#### NOTE:

The cable size and the current of the fuse or switch are determined by the maximum current indicated on the nameplate which located on the side panel of the unit. Please refer to the nameplate before selecting the cable, fuse and switch.

#### Connect the cable to the indoor unit

**NOTE:** Before performing any electrical work, turn off the main power to the system.

1. The inside and outside connecting cable can be connected without removing the front grille.
2. Lift the indoor unit panel up, remove the electrical box cover by loosening the screw.
3. Ensure the colour of wires of outdoor unit and the terminal Nos. are the same to the indoor's respectively.
4. Wrap those cables not connected with terminals with insulation tapes, so that they will not touch any electrical components. Secure the cable onto the control board with the cord clamp.

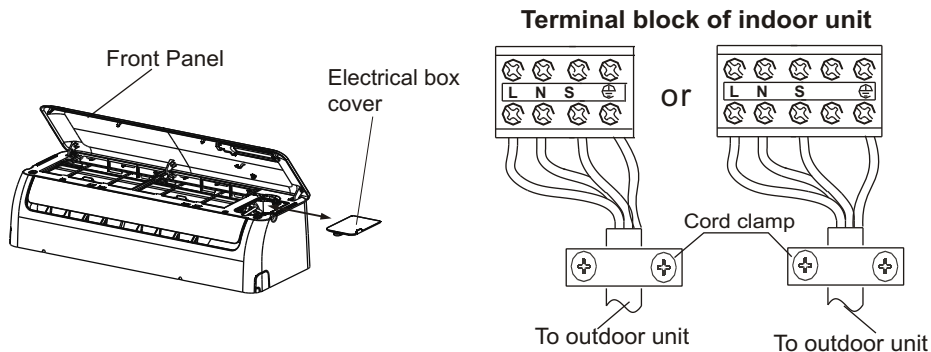

### 4 CONNECTIVE PIPE AND DRAINAGE INSTALLATION

#### Drainage

1. Run the drain hose sloping downward. Do not install the drain hose as illustrated in wrong figures.
2. When connecting extension drain hose, insulate the connecting part of extension drain hose with a shield pipe, do not let the drain hose slack.

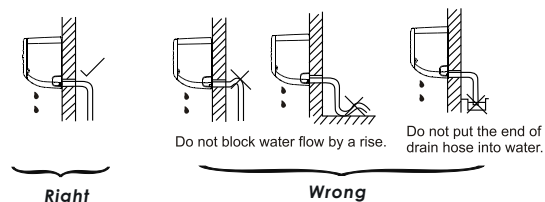



### **Connective pipe installation**

1. For the left-hand and right-hand piping, remove the pipe cover from the side panel.
2. For the right back and left back piping, install the piping as shown.

**NOTE:** One side drainage structure is standard. Both sides drainage structure is optional and can only be customized from factory. For both sides drainage structure, it can be chosen for right, left or both sides drainage connection. If choosing both sides drainage connection, another proper drain hose is needed as there is only one drain hose offered by factory. If choosing one side drainage connection, make sure the drain hole on the other side is well plugged. For 9k/12k models, if choosing right side drainage connection, please choosing right-hand or right-back piping. The connection of the drain hose is supposed to be done by qualified installer in case of water leakage.

3. Bundle the tubing, connecting cable, and drain hose with tape securely, evenly as shown in Figure on the right.

- Because the condensed water from rear of the indoor unit is gathered in ponding box and is piped out of room. Do not put anything else in the box.

### **CAUTION**

- Connect the indoor unit first, then the outdoor unit.
- Do not allow the piping to let out from the back of the indoor unit.
- Be careful not to let the drain hose slack.
- Heat insulation should be done to the extension drain hose of indoor unit.
- Be sure that the drain hose is located at the lowest side of the bundle. Locating at the upper side can cause drain pan to overflow inside the unit.
- Never intercross nor intertwist the power wire with any other wiring.

### **Indoor unit installation**

1. Pass the piping through the hole in the wall.
2. Hook the indoor unit onto the upper portion of installation plate (Engage the indoor unit with the upper edge of the installation plate). Ensure the hooks are properly seated on the installation plate by moving it in left and right.
3. Piping can easily be made by lifting the indoor unit with a cushioning material between the indoor unit and the wall. Get it out after finish piping.
4. Press the lower left and right side of the unit against the installation plate until hooks engages with their slots.

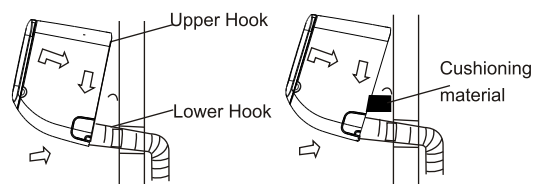
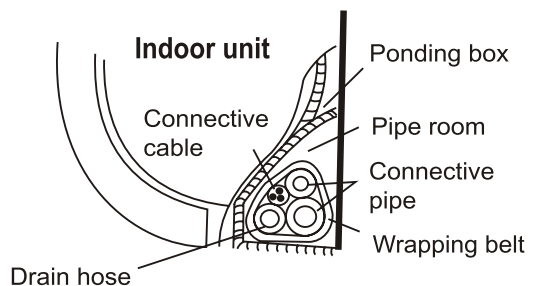
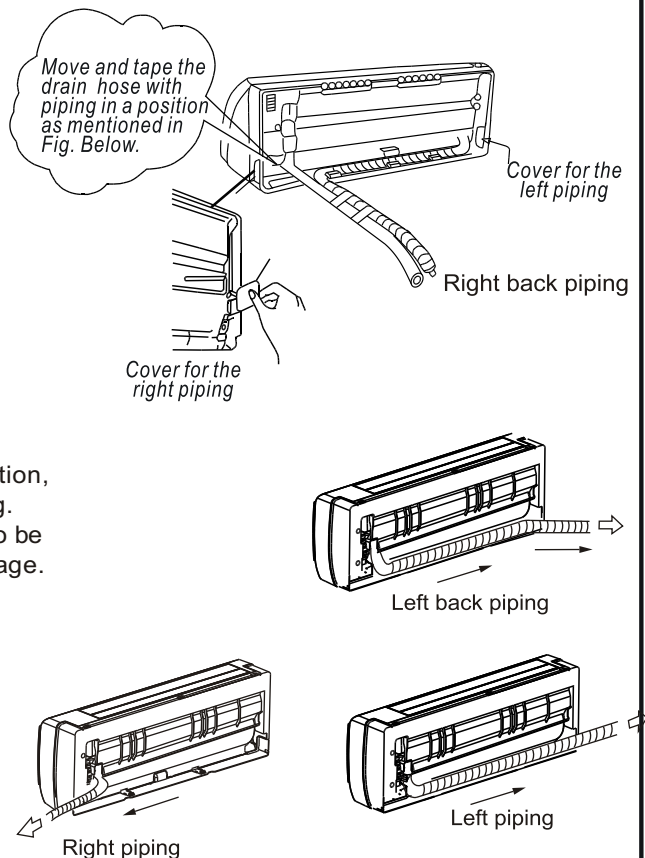

# OUTDOOR UNIT

## 1 OUTDOOR INSTALLATION PRECAUTION

- Install the outdoor unit on a rigid base to prevent increasing noise level and vibration.
- Determine the air outlet direction where the discharged air is not blocked.
- In the case that the installation place is exposed to strong wind such as a seaside, make sure the fan operating properly by putting the unit lengthwise along the wall or using a dust or shield plates.
- Specially in windy area, install the unit to prevent the admission of wind. If need suspending installation, the installation bracket should accord with technique requirement in the installation bracket diagram. The installation wall should be solid brick, concrete or the same intensity construction, or actions to reinforce, damping supporting should be taken.
- The connection between bracket and wall, bracket and the air conditioner should be firm, stable and reliable.
- Be sure there is no obstacle which block radiating air.

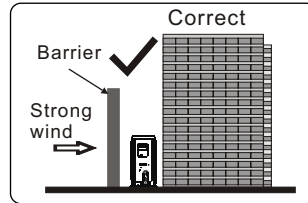
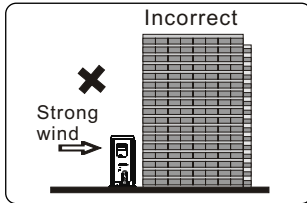

## 2 DRAIN JOINT INSTALLATION

**NOTE:** The drain joint is slightly different according to the different outdoor unit.

For the drain joint with the seal(Fig.A), first fit the seal onto the drain joint, then insert the drain joint into the base pan hole of outdoor unit, rotate 90° to securely assemble them. To install drain joint as shown in Fig.B, insert the drain joint into the base pan hole of outdoor unit until it remains fixed with a clicking sound. Connecting the drain joint with an extension drain hose (Locally purchased), in case of the water draining off the outdoor unit during the heating mode.

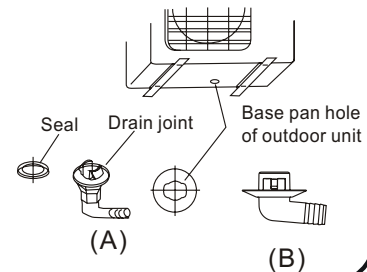

## 3 REFRIGERANT PIPE CONNECTION

### Flaring

1. Cut a pipe with a pipe cutter.
2. Put flare nuts on pipe/tube having completed burr removal and flare the pipe.
3. Firmly hold copper pipe in a die in the dimension shown in the table below.

Outer diam. (mm)	A(mm)	
	Max.	Min.
φ 6.35	1.3	0.7
φ 9.52	1.6	1.0
φ 12.7	1.8	1.0
φ 16	2.2	2.0

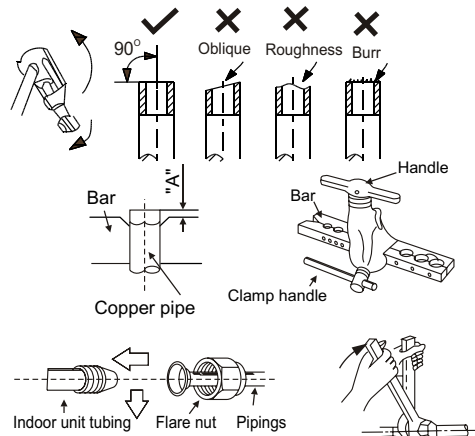

### Tightening connection

- Align pipes to be connected.
- Sufficiently tighten the flare nut with fingers, and then tighten it with a spanner and torque wrench as shown.
- Excessive torque can break nut depending on installation conditions.

Outer diam.	Tightening torque(N.cm)	Additional tightening torque(N.cm)
φ 6.35mm	1500 (153kgf.cm)	1600 (163kgf.cm)
φ 9.52mm	2500 (255kgf.cm)	2600 (265kgf.cm)
φ 12.7mm	3500 (357kgf.cm)	3600 (367kgf.cm)
φ 16mm	4500 (459kgf.cm)	4700 (479kgf.cm)



# 4

## CONNECT THE CABLE TO THE OUTDOOR UNIT

1. Remove the electrical control board cover from the outdoor unit by loosening the screw.
2. Connect the connective cables to the terminals as identified with their respective matched numbers on the terminal block of indoor and outdoor units.
3. Secure the cable onto the control board with the cord clamp.
4. To prevent the ingress of water, form a loop of the connective cable as illustrated in the installation diagram of indoor and outdoor units.
5. Insulate unused cords (conductors) with PVC-tape. Process them so they do not touch any electrical or metal parts

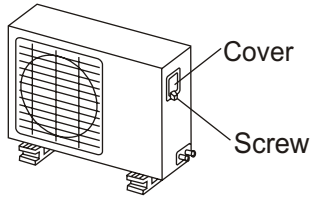

Terminal block of outdoor unit

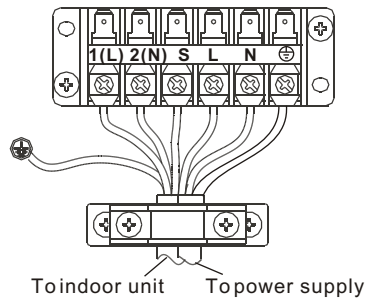

# 5

## AIR PURGING AND TEST OPERATION

### 1. Airpurging

- The indoor unit and tubing between the indoor and outdoor unit must be leak tested and evacuated to remove any noncondensables and moisture from the system.
- Check that each tube(both liquid and gas side tubes) between the indoor and outdoor units have been properly connected and all wiring for the test run has been completed.
- Pipe length and refrigerant amount:

Connective pipe length	Air purging method	Additional amount of refrigerant to be charged	
Less than 7.5m	Use vacuum pump	—————	
More than 7.5m	Use vacuum pump	Liquid side: $\phi$ 6.35mm R22: (Pipe length-5)x30g/m R410A: (Pipe length-5)x20g/m	Liquid side: $\phi$ 9.52mm: R22: (Pipe length-5)x60g/m R410A: (Pipe length-5)x40g/m

- For the R410A refrigerant model, make sure the refrigerant added into air conditioner is liquid form in any cases.
- When relocating the unit to another place, using vacuum pump to perform evacuation.

### CAUTION

- Open the valve stem until it hits against the stopper. Do not try to open it further.
- Securely tighten the valve stem cap with a spanner or the like.
- Valve stem cap tightening torque. See Tightening torque table.

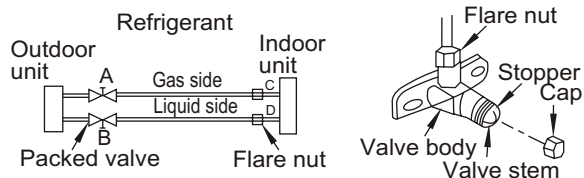

## **2. When using the Vacuum Pump**

1. Completely tighten the flare nuts, A, B, C, D, connect the manifold valve charge hose to a charge port of the packed valve on the gas pipe side.
2. Connect the charge hose connection to the vacuum pump.
3. Fully open the handle Lo of the manifold valve.
4. Operate the vacuum pump to evacuate. After starting evacuation, slightly loose the flare nut of the packed valve on the gas pipe side and check that the air is entering. (Operation noise of the vacuum pump changes and a compound meter indicates 0 instead of minus)
5. After the evacuation is complete, fully close the handle Lo of the manifold valve and stop the operation of the vacuum pump.
  - Make evacuation for 15 minutes and more and check that the compound meter indicates  $-76\text{cmHg}$  ( $-1.0 \times 10^5 \text{Pa}$ ).
6. Turn the stem of the packed valve B about  $45^\circ$  counter-clockwise for 6~7 seconds after the gas coming out, then tighten the flare nut again. Make sure the pressure display in the pressure indicator is a little higher than the atmosphere pressure.
7. Remove the charge hose from the Low pressure charge hose.
8. Fully open the packed valve stems B and A.
9. Securely tighten the cap of the packed valve.

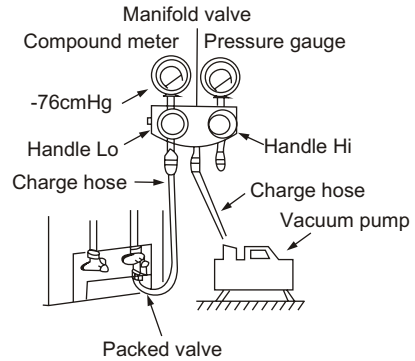

## **3. Safety and leakage check**

1. Soap water method:  
Apply a soap water or a liquid neutral detergent on the indoor unit connections and outdoor unit connections by a soft brush to check for leakage of the connecting points of the piping. If bubbles come out, it indicates that the pipes have leakage.
2. Leak detector  
Use the leak detector to check for leakage.

### **CAUTION**

A: Lo packed valve B: Hi packed valve  
C and D are ends of indoor unit connection.

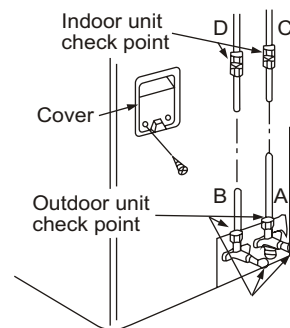

## **4. Test running**

Perform test operation after completing gas leak check at the flare nut connections and electrical safety check.

- Check that all tubing and wiring have been properly connected.
  - Check that the gas and liquid side service valves are fully open.
1. Connect the power, press the ON/OFF button on the remote controller to turn the unit on.
  2. Use the MODE button to select COOL, HEAT, AUTO and FAN to check if all the functions works well.
  3. When the ambient temperature is too low (lower than  $17^\circ\text{C}$ ), the unit cannot be controlled by the remote controller to run at cooling mode, manual operation can be taken. Manual operation is used only when the remote controller is disable or maintenance necessary.
    - Hold the panel sides and lift the panel up to an angle until it remains fixed with a clicking sound.
    - Press the Manual control button to select the AUTO or COOL, the unit will operate under Forced AUTO or COOL mode (see User Manual for details).
  4. The test operation should last about 30 minutes.

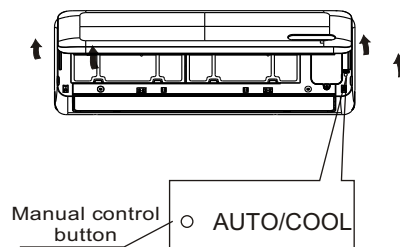

**Before using your air conditioner, please read this manual carefully and keep it for future reference.**

# **INVERTER SPLIT-TYPE ROOM AIR CONDITIONER**

## **USER'S MANUAL**

### **Read This Manual**

Keep this manual where the operator can easily find them. Inside you will find many helpful hints on how to use and maintain your air conditioner properly. Just a little preventative care on your part can save you a great deal of time and money over the life of your air conditioner. You'll find many answers to common problems in the chart of troubleshooting tips. If you review the chart of Troubleshooting Tips first, you may not need to call for service.

**⚠ CAUTION**

- Contact the authorized installer for installation of this unit.
- Contact an authorized service technician for repair or maintenance of this unit.
- This appliance is not intended for use by persons (including children) with reduced physical, sensory or mental capabilities, or lack of experience and knowledge, unless they have been given supervision or instruction concerning use of the appliance by persons responsible for their safety.
- Young children should be supervised to ensure that they do not play with the air conditioner.
- If the power cord is to be replaced, replacement work shall be performed by authorized personnel only.
- Installation work must be performed in accordance with the national wiring standards by authorized personnel only.

**When using this air conditioner in the European countries, please read the following information:**

**DISPOSAL:** Do not dispose of this product as unsorted municipal waste. Collection of such waste separately for special treatment is necessary.

It is prohibited to dispose of this appliance in domestic household waste.

For disposal, there are several possibilities:

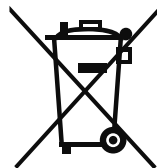

- A) The municipality has established collection systems, where electronic waste can be disposed of at least free of charge to the user.
- B) When buying a new product, the retailer will take back the old product at least free of charge.
- C) The manufacturer will take back the old appliance for disposal at least free of charge to the user.
- D) As old products contain valuable resources, they can be sold to scrap metal dealers.

Wild disposal of waste in forests and landscapes endangers your health when hazardous substances leak into the ground-water and find their way into the food chain.





## SAFETY PRECAUTIONS

To prevent injury to the user or other people and property damage, the following instructions must be followed. Incorrect operation due to ignoring of instructions may cause harm or damage. The seriousness is classified by the following indications.

 <b>WARNING</b>	This symbol indicates the possibility of death or serious injury.
 <b>CAUTION</b>	This symbol indicates the possibility of injury or damage to property.

■ Meanings of symbols used in this manual are as shown below.

	<b>Never do this.</b>
	<b>Always do this.</b>

### **WARNING**

#### ① Connect with the power properly.

- Otherwise, it may cause electric shock or fire due to excess heat generation.

#### ⊘ Do not operate or stop the unit by switching on or off the power.

- It may cause electric shock or fire due to heat generation.

#### ⊘ Do not damage or use an unspecified power cord.

- It may cause electric shock or fire.

#### ⊘ Do not modify power cord length or share the outlet with other appliances

- It may cause electric shock or fire due to heat generation.

#### ⊘ Do not operate with wet hands or in damp environment.

- It may cause electric shock.

#### ⊘ Do not direct airflow at room occupants only.

- This could damage your health.

#### ① Always ensure effective grounding.

- No grounding may cause electric shock.

#### ⊘ Do not allow water to run into electric parts.

- It may cause failure of machine or electric shock.

#### ① Always install circuit breaker and a dedicated power circuit.

- No installation may cause fire and electric shock.

#### ① Disconnect the power if strange sounds, smell, or smoke comes from it.

- It may cause fire and electric shock.

#### ⊘ Do not drink water drained from air conditioner.

- It contains contaminants and could make you sick.

#### ⊘ Do not open the unit during operation.

- It may cause electric shock.

#### ① Use the correctly rated breaker or fuse.

- There is risk of fire or electric shock.

#### ⊘ Do not use the power cord close to heating appliances.

- It may cause fire and electric shock.

#### ⊘ Do not disassemble or modify unit.

- It may cause failure and electric shock.

#### ① Ventilate room before operating air conditioner if there is a gas leakage from another appliance.

- It may cause explosion, fire and burns.

#### ⊘ Do not use the power cord near flammable gas or combustibles, such as gasoline, benzene, thinner, etc.

- It may cause explosion or fire.

**⚠ CAUTION**

⊘ When the air filter is to be removed, do not touch the metal parts of the unit.

- It may cause an injury.

⊘ When the unit is to be cleaned, switch off, and turn off the circuit breaker.

- Do not clean unit when power is on as it may cause fire, electric shock or injury.

⊘ Stop operation and close the window in storm or hurricane.

- Operation with windows opened may cause wetting of indoor and soaking of household furniture.

⊘ Do not use strong detergent such as wax or thinner. Use a soft cloth for cleaning.

- Appearance may be deteriorated due to change of product color or scratching of its surface.

⊘ Do not place heavy object on the power cord and take care so that the cord is not compressed.

- There is danger of fire or electric shock.

Do not clean the air conditioner with water.

- Water may enter the unit and degrade the insulation. It may cause an electric shock.

⊘ Do not put objects like thin rods into the panel of blower and suction side.

- The high-speed fan inside may cause danger.

⊘ Do not put a pet or house plant where it will be exposed to direct air flow.

- This could injure the pet or plant.

⊘ Do not place obstacles around air-inlets or inside of air-outlet.

- It may cause failure of appliance or accident.

⊘ Ensure that the installation bracket of the outdoor appliance is not damaged due to prolonged exposure.

- If bracket is damaged, there is concern of damage due to falling of unit.

⊘ Use caution when unpacking and installing. Sharp edges could cause injury.

⊘ Ventilate the room well when used together with a stove, etc.

- An oxygen shortage may occur.

⊘ Do not use for special purposes.

- Do not use this air conditioner to preserve precision devices, food, pets, plants, and art objects. It may cause deterioration of quality, etc.

⊘ Turn off the main power switch when not using the unit for a long time.

- It may cause failure of product or fire.

⊘ Always insert the filters securely. Clean filter once every two weeks.

- Operation without filters may cause failure.

⊘ If water enters the unit, turn the unit off and disconnect the power, contact a qualified service technician.



# OPERATING INSTRUCTIONS

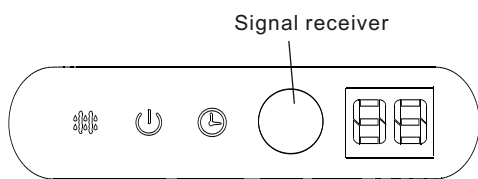
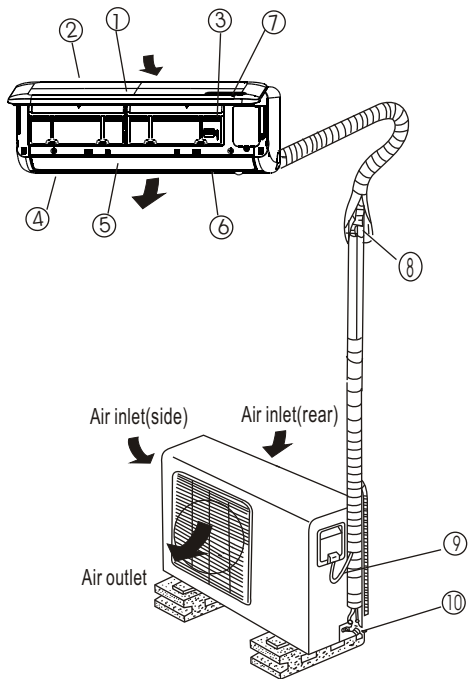

(A)

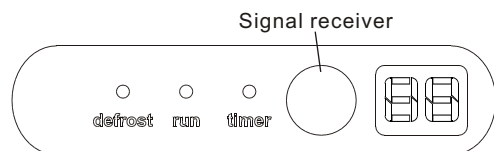

(B)

## Indoor unit

1. Front panel
2. Air inlet
3. Air filter
4. Air outlet
5. Horizontal air flow grille
6. Vertical air flow louver (inside)
7. Display panel

**NOTE:** The actual shape of the indoor unit you purchased may be slightly different on front panel and display window.

## Outdoor unit

8. Connecting pipe
9. Connecting cable
10. Stop valve

### NOTE:

All the pictures in this manual are for explanation purposes only. Your air conditioner may be slightly different. The actual shape shall prevail.

## VLED Display Window



### **OPERATION indication lamp**

This lamp illuminates when the air conditioner is in operation.



### **TIMER indication lamp**

Lights up during Timer operation.



### **DEFROST indication lamp**

(Enabled on cooling & heating models only):  
Lights up when the air conditioner starts defrosting automatically or when the warm air control feature is activated in heating operation.



### **Temperature indicator**

- Displays the temperature settings when the air conditioner is operational.
- Displays the malfunction code.

## Model Name And Dimensions

MODEL	WIDTH (mm)	HEIGHT(mm)	DEPTH(mm)
9000 Btu	680	255	180
12000 Btu	770	255	188
18000 Btu	905	275	198
24000 Btu	1030	315	220

## **Special functions**

### **Refrigerant Leakage Detection**

With this new technology, the display area will appear 'EC' and the indication lamps continue flashing when the outdoor unit detects refrigerant leakage.

### **Louver Angle Memory Function(optional):**

Within the scope of safety angle, it will memorize the open angle of horizontal louver. If it exceeds, it will memorize the boundary of safety angle. In the following circumstances, it will return to standard angle: 1) pressing the turbo or manual control button, 2) unplug and then plug in the machine. So we strongly suggest that the open angle of the horizontal louver should not be set too small, in case the condensed water forms and drops from the horizontal louver.

### **SELF CLEAN function (Optional)**

- Function used after the Shut Down of cooling operation to clean the Evaporator and keep it as fresh for the next operation.
- The unit will operate as following sequence : FAN ONLY mode at Low fan speed--Heating operation with LOW fan speed(applicable to cooling & heating modes only) ---FAN ONLY operation--Stop Operation---Turn off.

#### **Note:**

- This function is only available under COOL(AUTO COOL, FORCED COOL) and DRY mode.
- Before select the function, it is recommended to run the air conditioner under Cooling operation for about half an hour. Once the Self Clean function is activated, all TIMER setting will be cancelled.
- During Self Clean operation, when press the SELF CLEAN button on the remote controller again will stop the operation and turn off the unit automatically.

### **CLEAN AIR function(on some models)**

Improving the quality of indoor air is one of the purposes of an air conditioner. This air conditioner is equipped with ionizer or Plasma Dust Collector(Depending on specific configuration of the model). With the anions generated by Ionizer, the air circulation of the air conditioner fills the room with refreshing, natural and healthy air. The Plasma Dust Collector generates a high voltage ionization zone, through which the air is converted to plasma. Inside the air most of the dust, smoke, and pollen particles are captured by the electrostatic filter.

### **Anti-mildew function (Optional)**

When turns off the unit on COOL, DRY, AUTO (Cool) mode, the air conditioner will continue operating for about 7-10 minutes (depending on models) with soft wind. This will help to dry up the condensed water inside the evaporator, and prevent the breeding of mildew. Under Anti-mildew operation, do not restart the air conditioner until the unit is completely off.

# OPERATING INSTRUCTIONS

**NOTE:** This manual does not include Remote Controller Operations, see the <<Remote Controller Instruction>> packed with the unit for details.

## Operating temperature

Mode	Cooling operation	Heating operation	Drying operation
Room temperature	$\geq 17^{\circ}\text{C}$ (62°F)	$\leq 30^{\circ}\text{C}$ (86°F)	$> 10^{\circ}\text{C}$ (50°F)
Outdoor temperature	0°C~50°C (32°F~122°F)	-15°C~30°C ( 5°F~ 86°F)	0°C~50°C (32°F~122°F)
	(-15°C~ 50°C/ 5°F~ 122°F: For the models with low temperature cooling system)		

### NOTE:

- Optimum performance will be achieved within these operating temperatures. If air conditioner is used outside of the above conditions, certain safety protection features might come into operation and cause the unit to function abnormally.
- Room relative humidity less than 80%. If the air conditioner operates in excess of this figure, the surface of the air conditioner may attract condensation. Please sets the vertical air flow louver to its maximum angle (vertically to the floor), and set HIGH fan mode.

**Suggestion:** For the unit adopts an Electric Heater, when the outside ambient temperature is below 0°C(32°F), we strongly recommend you to keep the machine plugged in order to guarantee it running smoothly.

## Manual operation

Manual operation can be used temporarily in case the remote controller is disable or the unit requires maintenance.

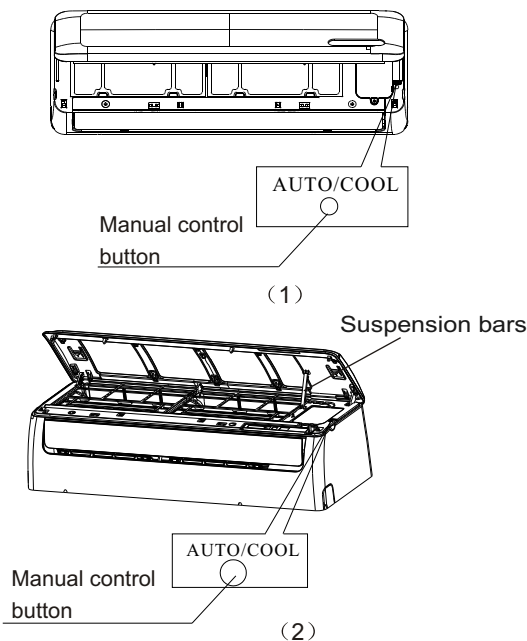

**NOTE:** The unit must be turned off before operating the manual control button. If the unit is operational, continue pressing the manual control button until the unit is off.

- Open and lift the front panel up to an angle until it remains fixed with a clicking sound.
- For 24K Btu model, please use suspension bars to prop up the panel.
- One press of the manual control button will lead to the forced AUTO operation. If press the button twice within five seconds, the unit will operate under forced COOL operation. Close the panel firmly to its original position.

### CAUTION:

- This button is used for testing purposes only. You had better not choose it.
- To restore the remote controller operation, use the remote controller directly.

## Airflow direction control

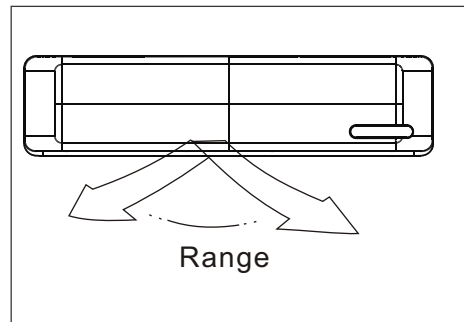
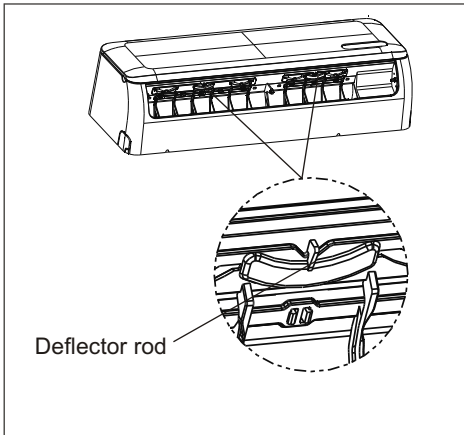
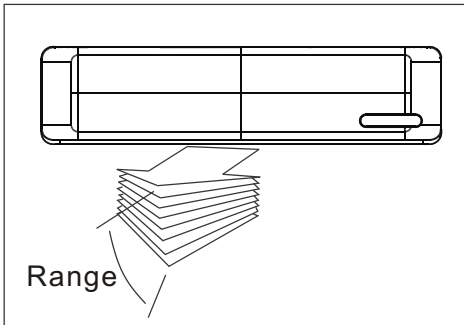

Adjust the air flow direction properly otherwise it might cause discomfort or cause uneven room temperatures.

Adjust the horizontal louver using the remote controller.

Adjust the vertical louver manually.

### To set the vertical air flow(Up--Down) direction

Perform this function while the unit is in operation.

Use the remote controller to adjust the air flow direction. The horizontal louver can be moved at a range of  $6^\circ$  for each press, or swing up and down automatically. Please refer to the 'REMOTE CONTROLLER OPERATION MANUAL' for details.

### To set the horizontal air flow direction (left - right)

- Move the deflector rod manually to adjust the air flow in the direction you prefer.

**IMPORTANT:** Do not put your fingers into the panel of blower and suction side. The high-speed fan inside may cause danger.

### CAUTION

- Do not operate the air conditioner for long periods with the air flow direction set downward in cooling or dehumidifying mode. Otherwise, condensation may occur on the surface of the horizontal louver causing moisture to drop on to the floor or on furnishings.
- When the air conditioner is started immediately after it was stopped, the horizontal louver might not move for approximately 10 seconds.
- Open angle of the horizontal louver should not be set too small, as COOLING or HEATING performance may be impaired due to too restricted air flow area.
- Do not move the horizontal louver manually, otherwise the horizontal louver will be out of sync. Please cease operating, unplug power for a few seconds, then restart the air conditioner.
- Do not operate unit with horizontal louver in closed position.

# OPERATING INSTRUCTIONS

## How the air conditioner works

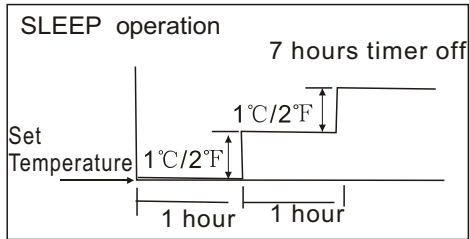

### Cooling

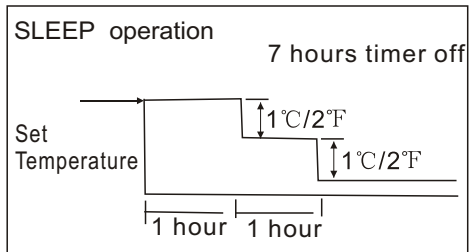

### Heating

### AUTO operation

- When you set the air conditioner in AUTO mode, it will automatically select cooling, heating (cooling/heating models only), or fan only operation depending on set temperature and the room temperature.
- The air conditioner will control room temperature automatically to the temperature point you set.
- If you feel uncomfortable in the AUTO mode, you can set your desired temperature.

### SLEEP operation

When you push SLEEP button on remote controller during cooling, heating (cooling & heating models only), or AUTO operation, the air conditioner will automatically increase (cooling) or decrease (heating) 1°C/2°F per hour for the first 2 hours, then hold steadily for the next 5 hours, after that it will switch off. This mode saves you energy and brings you comfort at night.

### DRYING operation

- The fan speed will be automatically controlled under dry operation.
- During the dry operation, if the room temperature is lower than 10°C (50°F), the compressor stops operation and restarts until the room temperature is above 12°C (54°F).

### Optimal operation

- To achieve optimal performance, please note the following:
  - Adjust the air flow direction correctly so that it is not forwards people.
  - Adjust the temperature to achieve the highest comfort level. Do not adjust the unit to excessive temperature levels.
  - Close doors and windows on COOL or HEAT modes, or performance may be reduced.
  - Use TIMER ON button on the remote controller to select a time you want to start your air conditioner.
  - Do not put any object near air inlet or air outlet, as the efficiency of the air conditioner may be reduced and the air conditioner may stop running.
  - Clean the air filter periodically, otherwise cooling or heating performance may be reduced.
- Do not operate unit with horizontal louvre in closed position.

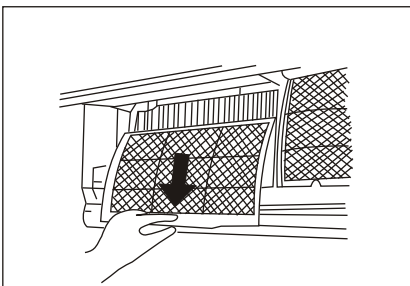
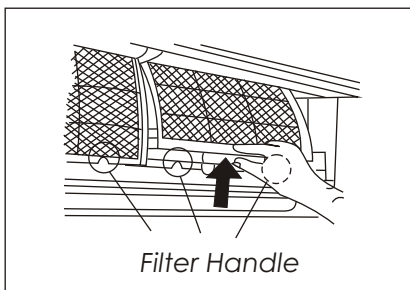
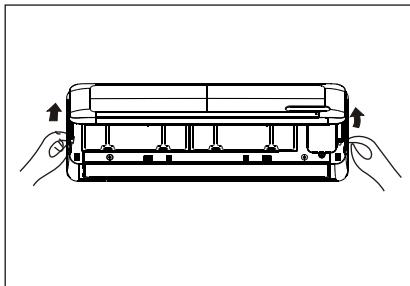
**Care and Maintenance****Cleaning the Grille, Case and Remote Controller**

- Turn the system off before cleaning. To clean, wipe with a soft, dry cloth. Do not use bleach or abrasives.

**NOTE: Power supply must be disconnected before cleaning the indoor unit.**

**CAUTIONS**

- A cloth dampened with cold water may be used on the indoor unit if it is very dirty. Then wipe it with a dry cloth.
- Do not use a chemically treated cloth or duster to clean the unit.
- Do not use benzene, thinner, polishing powder, or similar solvents for cleaning. These may cause the plastic surface to crack or deform.
- Never use water hotter than 40°C/104°F to clean the front panel, it could cause deformation or discoloration.

**Cleaning the air filter**

**NOTE: Power supply must be disconnected before cleaning the indoor unit.**

A clogged air filter reduces the cooling efficiency of this unit. Please clean the filter once every 2 weeks.

1. Lift the indoor unit panel up to an angle until it stops with a clicking sound. For 24K Btu model, please use suspension bars to prop up the panel.
2. Take hold of the handle of the air filter and lift it up slightly to take it out from the filter holder, then pull it downwards.
3. Remove the AIR FILTER from the indoor unit.  
Clean the AIR FILTER once two weeks.  
Clean the AIR FILTER with a vacuum cleaner or water, then dry it up in cool place.



## CARE AND MAINTENANCE

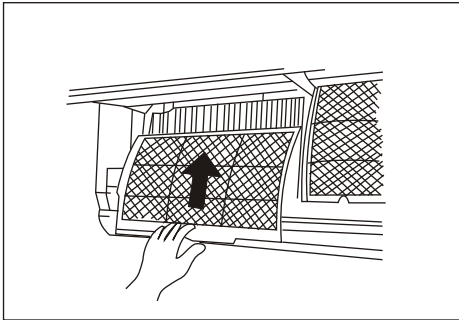
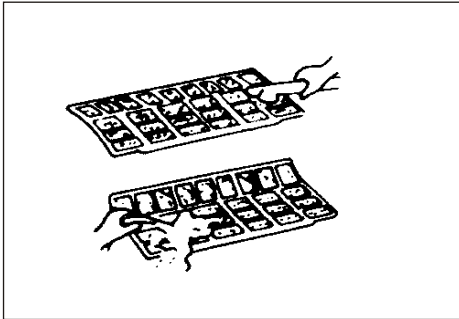
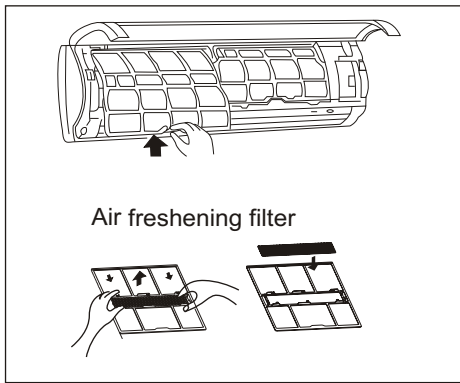

4. Remove the Air Freshening Filter from its supporting frame (on some models).
  - Clean the air freshening filter at least once a month, and replace it every 4-5 months.
  - Clean it with vacuum cleaner, then dry it in cool place.
5. Install the air freshening filter back into position.
6. Insert the upper portion of air filter back into the unit, taking care that the left and right edges line up correctly and place filter into position.

### Maintenance

If you plan to idle the unit for a long time, perform the following:

- (1) Clean the indoor unit and filters.
  - (2) Operate the fan for about half a day to dry the inside of the unit.
  - (3) Stop the air conditioner and disconnect power.
  - (4) Remove the batteries from the remote controller.
- The outdoor unit requires periodic maintenance and cleaning. Do not attempt to do this yourself. Contact your dealer or service provider.

### Checks before operation

- Check that the wiring is not broken off or disconnected.
- Clean the indoor unit and filters.
- Check that the air filter is installed.
- Check if the air outlet or inlet is blocked after the air conditioner has not been used for a long time.

### **Caution**

- Do not touch the metal parts of the unit when removing the filter. Injuries can occur when handling sharp metal edges.
- Do not use water to clean inside the air conditioner. Exposure to water can destroy the insulation, leading to possible electric shock.
- When cleaning the unit, first make sure that the power and circuit breaker are turned off.
- Do not wash with hot water at more than 40°C. Shake off moisture completely and dry it in the shade; do not expose it directly to the sun. The filter may shrink.

The following events may occur during normal operation.

**1. Protection of the air conditioner.**

**Compressor protection**

- The compressor can't restart for 3 minutes after it stops.
- **Anti-cold air (Cooling and heating models only)**
  - The unit is designed not to blow cold air on HEAT mode, when the indoor heat exchanger is in one of the following three situations and the set temperature has not been reached.
    - A) When heating has just started.
    - B) Defrosting.
    - C) Low temperature heating.
  - The indoor or outdoor fan stop running when defrosting (Cooling and heating models only).
- **Defrosting (Cooling and heating models only)**
  - Frost may be generated on the outdoor unit during heat cycle when outdoor temperature is low and humidity is high resulting in lower heating efficiency of the air conditioner.
  - During this condition air conditioner will stop heating operation and start defrosting automatically.
  - The time to defrost may vary from 4 to 10 minutes according to the outdoor temperature and the amount of frost built up on the outdoor unit.

**2. A white mist coming out from the indoor unit**

- A white mist may generate due to a large temperature difference between air inlet and air outlet on COOL mode in an indoor environment that has a high relative humidity.
- A white mist may generate due to moisture generated from defrosting process when the air conditioner restarts in HEAT mode operation after defrosting.

**3. Low noise of the air conditioner**

- You may hear a low hissing sound when the compressor is running or has just stopped running. It is the sound of the refrigerant flowing or coming to a stop.
- You can also hear a low "squeak" sound when the compressor is running or has just stopped running. This is caused by heat expansion and cold contraction of the plastic parts in the unit when the temperature is changing.
- A noise may be heard due to louver restoring to its original position when power is turned on.

**4. Dust is blown out from the indoor unit.**

This is a normal condition when the air conditioner has not been used for a long time or during first use of the unit.

**5. A peculiar smell comes out from the indoor unit.**

This is caused by the indoor unit giving off smells permeated from building material, from furniture, or smoke.

**6. The air conditioner turns to FAN only mode from COOL or HEAT (For cooling and heating models only) mode.**

When indoor temperature reaches the temperature setting on air conditioner, the compressor will stop automatically, and the air conditioner turns to FAN only mode. The compressor will start again when the indoor temperature rises on COOL mode or falls on HEAT mode (For cooling and heating models only) to the set point.

**7. The air conditioner runs Anti-mildew function after turning off the unit.**

When turning off the unit under COOL(AUTO COOL, FORCED COOL) and DRY mode, the air conditioner will run Anti-mildew function for 7-10 minutes, then stop the operation and turn off the unit automatically.

## **OPERATION TIPS**

---

8. Dripping water may generate on the surface of the indoor unit when cooling in a high relative humidity (relative humidity higher than 80%). Adjust the horizontal louver to the maximum air outlet position and select HIGH fan speed.

### **9. Heating mode (For cooling and heating models only)**

The air conditioner draws in heat from the outdoor unit and releases it via the indoor unit during heating operation. When the outdoor temperature falls, heat drawn in by the air conditioner decreases accordingly. At the same time, heat loading of the air conditioner increases due to larger difference between indoor and outdoor temperature. If a comfortable temperature can't be achieved by the air conditioner, we suggest you use a supplementary heating device.

### **10. Auto-restart function**

- Power failure during operation will stop the unit completely.
  - For the unit without Auto-restart feature, when the power restores, the OPERATION indicator on the indoor unit starts flashing. To restart the operation, push the ON/OFF button on the remote controller. For the unit with Auto-restart feature, when the power restores, the unit restarts automatically with all the previous settings preserved by the memory function.
11. Lightning or a car wireless telephone operating nearby may cause the unit to malfunction. Disconnect the unit with power and then re-connect the unit with power again. Push the ON/OFF button on the remote controller to restart operation.

**Troubleshooting Tips**

<p>If one of the following faults occurs, stop the air conditioner immediately, disconnect the power and then connect it in again. If the problem still exists, disconnect the power and contact the nearest customer service center.</p>	
<b>Trouble</b>	OPERATION indicator or other indicators continue flashing.
	Fuse blows frequently or circuit breaker trips frequently.
	Other objects or water fall into the air conditioner.
	The remote controller won't work or works abnormally.
	If one of the following code appears on the display area : E0,E1,E2,E3.....or P0,P1,P2,P3.....

<b>Malfunctions</b>	<b>Cause</b>	<b>What should be done?</b>
<b>Unit does not start</b>	Power cut	Wait for power to be restored.
	Unit may have become Unplugged.	Check that plug is securely in wall receptacle.
	Fuse may have blown.	Replace the fuse.
	Battery in Remote controller may have been exhausted.	Replace the battery.
	The time you have set with timer is incorrect.	Wait or cancel timer setting.
<b>Unit not cooling or heating (Cooling/ heating models only) room very well while air flowing out from the air conditioner</b>	Inappropriate temperature setting.	Set temperature correctly. For detailed method please refer to "Using remote control" section.
	Air filter is blocked.	Clean the air filter.
	Doors or Windows are open.	Close the doors or windows.
	Air inlet or outlet of indoor or outdoor unit has been blocked.	Clear obstructions away first, then restart the unit.
	Compressor 3 or 4 minutes protection has been activated.	Wait.

If the trouble has not been corrected, please contact a local dealer or the nearest customer service center. Be sure to inform them of the detailed malfunctions and unit model number.

**Notes: Do not attempt to repair the unit yourself.  
Always consult an authorized service provider.**



*Comfort Where It Counts.*

2201 Dwyer Avenue,  
Utica NY 13501

*website: [www.enviromaster.com](http://www.enviromaster.com)*