

RETROAIRE™

The Right Fit for Comfort

ECR International Inc
2201 Dwyer Avenue
Utica, NY 13501
e-mail: info@RetroAire.com



An ISO 9001-2008 Certified Company

R30C/H

Packaged Terminal Air Conditioner (PTAC)
Packaged Terminal Heat Pump (PTHP)

Straight cooling nominal capacities

9,000	12,000	15,000	Btuh
2.6	3.5	4.4	kW

Heat pump nominal capacities

9,000	12,000	15,000	Btuh
2.6	3.5	4.4	kW

Installation, Operation, & Maintenance Manual

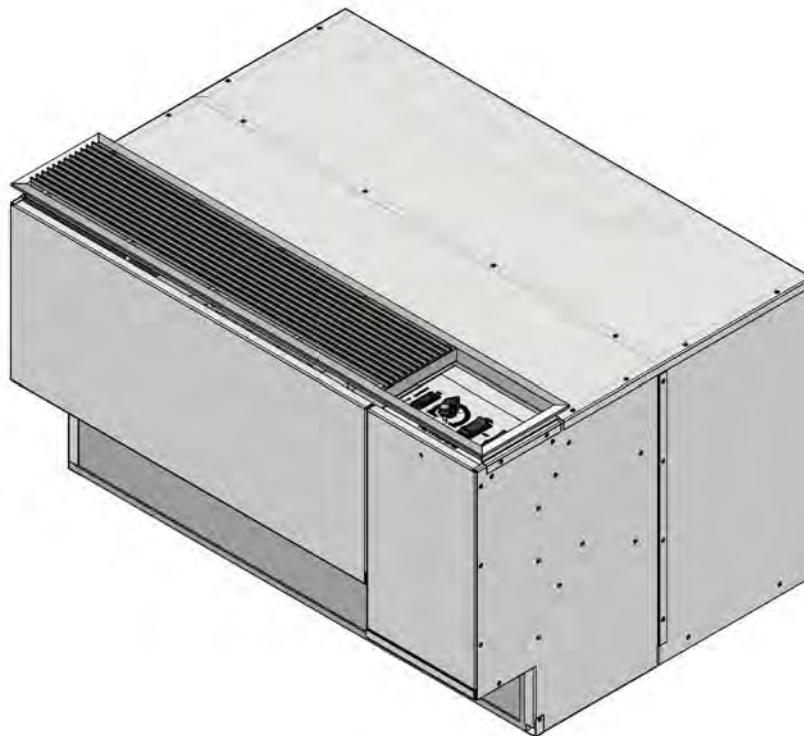

R30C | R30H

Replacement for:
ZoneAire & Keeprite C/CHP series,
and Carrier 51P/PH series
packaged terminal units.

Read This First

Contents

Read This First	2-3	
To the installer	2	
Inspection	3	
General precautions	3	
General Product Information	4-7	
Product description	4	
Standard controls and components.	4	
Factory-installed options (<i>consult the factory</i>)	4	
Field-installed options.	4	
R30C/R30H Chassis	5	
PTAC/PTHP Model Coding	6	
Features	7-8	
Optional wall-mounted thermostats	8	
Preparing for the Installation of the PTAC/PTHP	9	
Electrical power connection	9	
Remove the old chassis	9	
Installation Instructions — R30C R30H	10	
Sequence of Operation	11-12	
Initial Power-Up or power restoration	11	
R__C / R__H: Cooling Operation	11	
R__C / R__H: Heating Operation	12	
R__H: Mechanical Heating "Heat Pump".	12	
R__H: Auxiliary Heating "Electric" or "Hydronic"	12	
Final Inspection & Start-up	13-18	
Before operating the unit	13	
		Setting the control board jumpers 14 Start Up 15 Unit-mounted thermostat 15 Remote-mounted thermostat. 15 Straight cooling PTAC's 15-16 Heat Pump PTHP's 16-17 Start-up 18
		Maintenance & Troubleshooting 19-21 Monthly inspection and maintenance. 19 Seasonal start-up and maintenance. 19-20 Heat pump units — temporary emergency heating mode . 20 Troubleshooting sensors. 20 Troubleshooting 21
		Performance Data 22
		Electrical Specifications 23-25

To the installer

Retain this manual and warranty for future reference.

Before leaving the premises, review this manual to be sure the unit has been installed correctly and run the unit for one complete cycle to make sure it functions properly.

To obtain technical service or warranty assistance during or after the installation of this unit, contact your local representative. Visit our web site www.retroaire.com for a local representative listing. For further assistance call 1-800-228-9364.

When calling for assistance, please have the following information ready:

Model Number _____

Serial Number _____

Date of installation _____

NOTICE

The RetroAire™ replacement PTAC/PTHP is backed by EMI and ECR International and is tested and rated in accordance with:

AHRI Standards 310/380
UL-484

Due to ongoing product development, product designs and specifications may change without notice.

Please contact the factory for more information.

Read This First *(continued)*



Recognize this symbol as an indication of important safety information.

Inspection

- Carefully check the shipment against the bill of lading.
- Make sure correct chassis has been received (*as well as any options*).
- Verify your equipment by using “Model coding” on page 6.

Verify unit:

- Unit size and type correct per submittal sheet and job requirements?
- Voltage correct?

Verify options (if any):

- Capacity, electric heat if used?
- Hydronic coil included, if required? Piping located as required?
- All other factory installed options installed, if any?
- All field installed options included, if any?

Shipping damage **MUST** be reported to the carrier **IMMEDIATELY**.

- **Examine the exterior.**
- **Remove cover and examine compressor and piping for signs of damage.**
- Inspect each component for damage.
- Concealed damage must be reported to the carrier within **15 days** of the receipt of the shipment.
- The carrier must make proper notation on the delivery receipt of all damage identified and complete a carrier inspection report.
- The purchaser must notify ECR International’s Customer Service department of all damage and is responsible for filing any necessary claims with the carrier.

Customer Service : (800) 228-9364

General precautions

DANGER

Electrical Supply

Carefully read the rating plate located on the front panel. The RetroAire replacement PTAC/PTHP must:

- **Be properly connected** to electrical supply with the proper voltage as stated on the rating plate.
- **Be properly grounded.**
- **Use the properly-sized over-current protection device** as stated on the rating plate. (*time-delay fuse/HACR Breaker*)

Do not modify the RetroAire replacement PTAC/PTHP

Do not attempt to modify or change this unit in any way. Tampering with the RetroAire replacement PTAC/PTHP is dangerous and may result in serious injury or death. Tampering voids all warranties.

Power Cord

The **power cord** supplied with the RetroAire replacement PTAC/PTHP should be checked before every use. Follow the instructions in the order listed on the device. Do not use the product if the cord fails the test. A damaged power supply cord must be replaced with a new cord from the manufacturer and not repaired. The use of extension cords is prohibited.

Failure to follow these instructions can result in a fire, explosion or electrical shock causing property damage, personal injury or death.

WARNING — Safety instructions

Save these instructions — this manual is intended as an aid to **qualified service personnel** for proper installation, operation, and maintenance of the RetroAire replacement PTAC/PTHP.

Read all instructions thoroughly and carefully before attempting installation or operation. Install or locate this unit only in accordance with these instructions. Use this unit only for its intended use as described in this manual.

Turn off the electrical supply before servicing the unit.

PTAC/PTHP chassis are heavy. To avoid injury, use assistance when lifting.

Do not use the unit if it has damaged wiring, is not working properly, or has been damaged or dropped.

Failure to follow these instructions may result in improper installation, operation, service, or maintenance, possibly resulting in fire, electrical shock, property damage, personal injury, or death.

General Product Information

Product description

RetroAire Replacement Packaged Terminal Air Condition/Heat Pumps units are available in straight cooling (PTAC) or as heat pump systems (PTHP). Both the PTAC and PTHP configurations fit the wall sleeves of the units listed on the front cover. Heat pumps (PHTP) reduce energy costs and will operate in mechanical heat mode down to an outdoor temperature of 40°F (4.4°C), Below 40°F (4.4°C) heating is accomplished by an auxiliary heat option.

The Retroaire PTAC/PHTP units:

- Use R-410A refrigerant. This refrigerant is not affected by a phase out schedule.
- Include high-efficiency rotary compressors, protected by a 5-year warranty.
- Include an enhanced, high-efficiency heat exchangers.
- Offer two fan speeds.
- Incorporate positive condensate re-evaporation to improve efficiency.
- Have an optional motorized fresh-air feature with a positive pressure seal.

RetroAire PTAC/PHTP ratings meet or exceed ASHRAE 90.1 Standards for energy efficiency:

- PTAC/PHTP units are available in nominal sizes of 9,000 Btuh, (2.6kW) 12,000 Btuh (3.5kW) or 15,000 Btuh (4.4kW).
- PTAC units (straight cooling only) are also available at 18,000 Btuh (5.3kW).
- Energy Efficiency Rating (EER) as high as 10.
- Coefficient of performance (COP) ratings as high as 2.90 for heat pumps.

Standard controls and components

Construction

- 20-gauge galvanized steel construction of chassis.
- Condenser baffle options to accommodate extended wall sleeve applications. (Consult the factory for special order items).
- Powder-coated condenser and evaporator drain pan.
- Foam strip seal for supply air duct.
- Weather strip insulation.

Air systems

- Motors are thermally-protected PSC type.
- Air-stream surfaces are insulated with 1/4" fiber-glass or 1/8" (3.2 mm) Volara™.
- The indoor fan is a forward-curved type, directly mounted to the motor shaft.
- Unit mount controls include a field selection switch to control indoor fan by either cycling with compressor operation or continuously with the unit.

Condensate removal

- The outdoor fan incorporates condensate slinger ring — Condensate is thrown onto the coil, where it evaporates, improving system performance.
- Thermostatic drain pan valve for condensate elimination when outdoor temperature drops below 60°F (15°C) (heat pump units only).

Controls

- Unit-mounted operating controls include thermostat, fan speed control, heat/cool switch, fan cycle switch, fresh air switch (if equipped)
- Ability to utilize 1-stage or 2-stage thermostat. 2 stage thermostat is capable of activating emergency heat if an auxiliary heat source is available.
- Low ambient protection — see "Microprocessor control board" for details.
- Ability to control a normally-open or normally-closed motor valve switch (on hydronic heat units only). Valve controls must be ordered for 24V or line voltage.
- All hydronic heat units include molex plugs for connection of hydronic valve motor.
- Remote mount controls include fan speed control and fresh air switch (if equipped)
- All units are equipped with manual reset high pressure switch which prevents abnormal high pressure operation, increasing compressor reliability.

Microprocessor control board

- The universal control board is used in straight cooling, electric resistance heat, hydronic heat, or cooling/heat pump applications.
- Random start timer prevents multiple units from simultaneous startups after power interruption or on initial power-up.
- Fan purge — fan remains on for 60 seconds after heat/cool is satisfied.
- Anti-short-cycle compressor protection prevents the compressor from rapid cycling, increases compressor reliability.
- Freeze-protection prevents evaporator coil freeze up, improving compressor reliability.
- Low ambient lockout prevents compressor operation in outdoor temperatures less than 40°F (4.4°C). (On PHTP units supplied with unit-mounted control, the control causes automatic changeover to auxiliary heat, if installed.)
- Test operation — all timers are temporarily suppressed to allow ease of testing or troubleshooting.
- Control board LED provides self-diagnostic troubleshooting codes, see "Sequence of operation."

Factory-installed options *(consult the factory)*

- 265/277V (12 and 15 only)
- 115V (09 & 12 Models Only)
- Corrosion-resistant coil option — used for seacoast and harsh-environment usage; coated aluminum fin/copper tube condenser coil.
- Motorized fresh-air damper
- Supplemental electric heat — see heat options on "Model coding" on page 6.
- Hydronic heat controls
- Front air intake

Field-installed accessories

- Hydronic heat — the coil assembly is shipped loose for field installation.
- Remote wall thermostat — digital 1-stage or 2-stage available.
- Wall sleeves, louvers, and cabinets
- Aquastat - delays fan start-up until coil reaches 100°F (38°C) to virtually eliminate "cold" blow condition.
- Hydronic control valve, Water 2 way & 3 way
- Hydronic control valve, Steam 2 way
- Hydronic Isolation valve, 1/2 in Sweat Connection.

General Product Information *(continued)*

Figure 1 R30C | R0H chassis

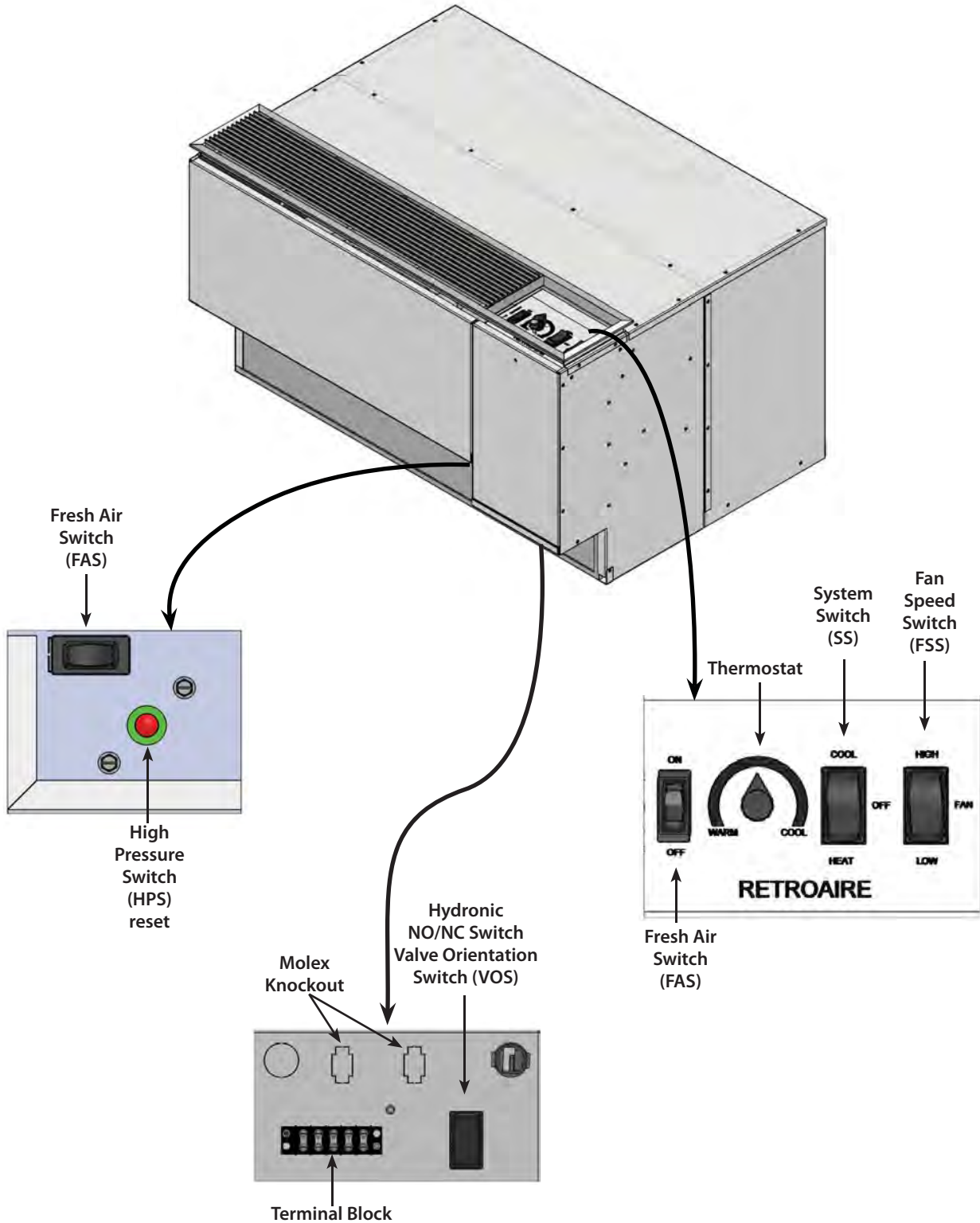

PTAC/PTHP Model Coding

Figure 2 Model coding

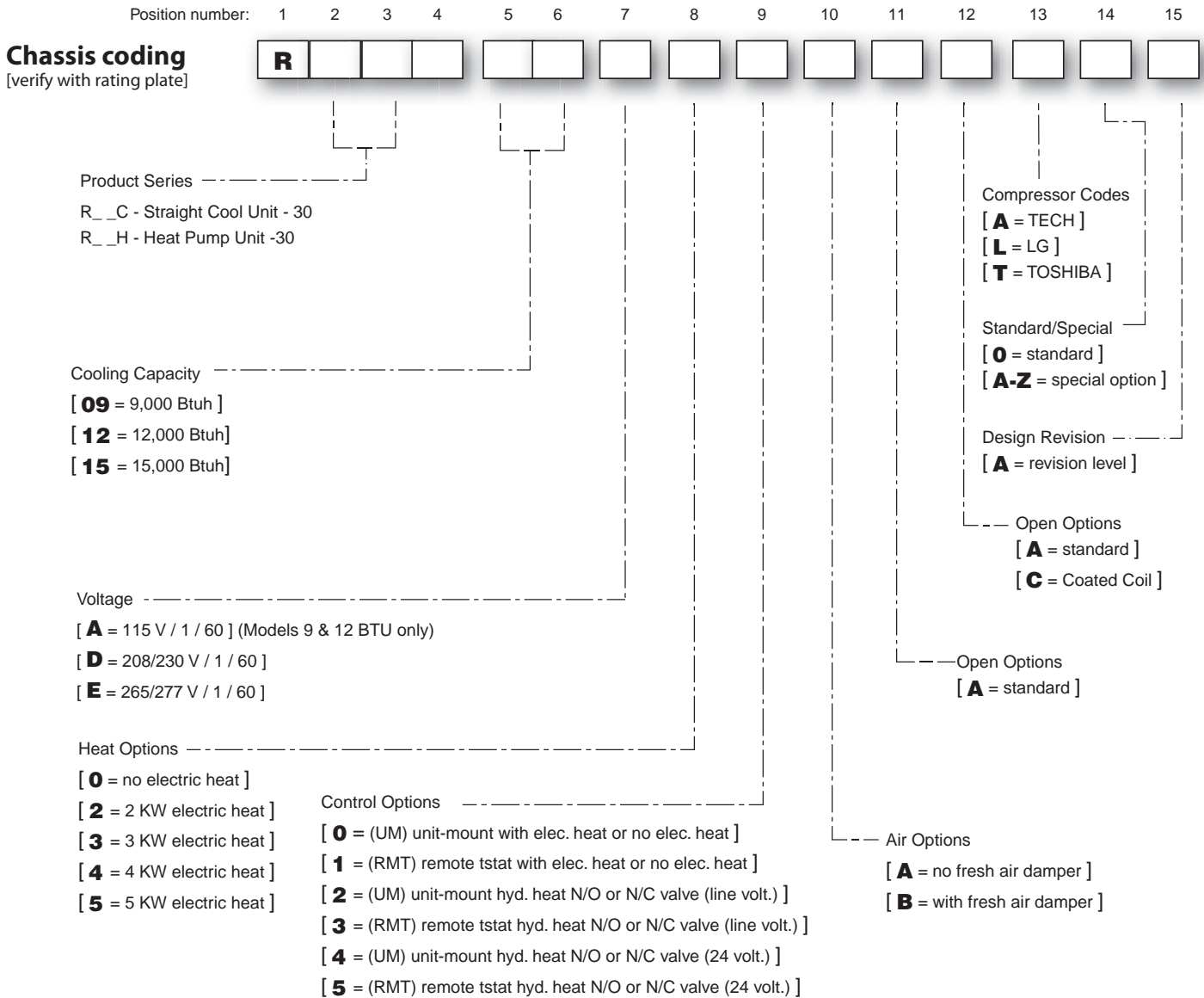

Field Installed Accessories [items to be selected during the ordering process]

<input type="checkbox"/>	Remote thermostat	<input type="checkbox"/>	Sea Coast Coated Coils (Factory Installed, consult factory)
<input type="checkbox"/>	Hydronic Heat		
<input type="checkbox"/>	Wall Sleeves, Louvers, & Cabinet (Consult Factory)		

Features

Indoor coil freeze protection *(standard)*

This feature will prevent the indoor coil from freeze up in the cooling mode.

- Indoor coil freeze up can occur due to a dirty air filter, restricted or poor air flow, low refrigerant charge or low room or outdoor temperatures.
- This in turn can cause compressor damage.
- Should a freeze condition be detected, the compressor and outdoor fan will be switched off for a minimum of three minutes until the freeze condition is satisfied.
- During this time the indoor fan will continue to run to aid in the defrost process.

Condensate removal *(standard)*

The RetroAire replacement unit (cooling operation) is designed to eliminate condensate by slinging it onto the outdoor coil.

- Condensate drains through the bulkhead to the area near the outdoor fan.
- As part of its normal operation, the unit will produce condensate and collect it in the base pan of the unit. There it is picked up by the outdoor fan slinger ring and deposited onto the condenser coil. During the cooling season, this improves the unit's efficiency by maintaining reduced refrigeration system pressures.
- Base pan has overflow notches, if too much condensate is produced notches allow condensate to flow out of the basepan and into the wallsleeve out of the building.

Thermostatic drain pan valve *(standard on heat pump units)*

On heat pump models (PTHP), condensate can accumulate in the outdoor drain pan during the heat pump cycle.

- PTHP units include a thermostatic drain valve that opens when outdoor temperatures fall below 60°F (15°C).
- When the drain valve opens, condensate flows from the drain pan onto the bottom of the wall sleeve, where it drains to the outside.
- This keeps the base pan free of condensate water, which could otherwise freeze during colder outdoor temperatures.

Random start feature *(standard)*

The random start feature is initiated on initial power-up or after a power interruption.

- The controller adds a random time delay (from 5–120 seconds) on start-up, preventing the compressor from starting.
- This staggers the starting of multiple units in a single facility, preventing a large surge that might occur if all units started at the same time.

Anti-short cycle timer *(standard)*

The microprocessor control uses this timing to prevent short-cycling of the compressor.

- When the compressor cycles off on a heating or cooling call, the controller starts a 180-second timer.
- The compressor will not be allowed to start until this time has elapsed.
- On initial power-up or after a power failure, this timing occurs after the random start timing.

Power cord with integral safety protection

(standard)

All PTAC/PTHP units rated 250v or less are equipped with a power cord with integral safety protection as standard.

- Providing personal shock protection as well as arcing and fire prevention, the device is designed to sense any damage in the line cord and disconnect power before a fire can occur.
- Tested in accordance with Underwriters Laboratories, the cord set also offers a unique “passive” operation, meaning the unit does not require resetting if main power is interrupted.

Heat pump

Heat pump units are “Limited Range” and should be equipped with back-up electric resistance or hydronic heat. Limited Range heat pumps are designed to operate when outdoor temperatures are between 75°F(24°C) and 40°F(4.4°C) and with a maximum indoor temperature of 80°F(26.6°C). The unit is equipped with a reversing valve that is energized for cooling and de-energized in heating mode. Electric heating or hydronic heat will operate using the onboard control logic below the operating conditions of the heat pump.

Hydronic heating *(optional)*

An optional hydronic heat package may be selected in lieu of electric heat. Heating operation is essentially the same as that of units with electric heat.

Aquastat connection *(optional)*

All replacement PTAC/PTHP's with hydronic heat are supplied with a standard line volt Aquastat connection. The field installed Aquastat delays the fan operation until the hydronic coil reaches a temperature of 100°F (38°C).

Features

Motorized fresh air damper (optional)

The optional motorized fresh air damper allows fresh air into the space to be conditioned. When the Fresh Air switch is in the "YES" position the damper door is open and allows fresh air into the space. This feature is only available when the indoor fan is on. When the damper door switch is in the "NO" position, the damper door is closed and does not allow air in the space.

Optional wall-mounted thermostats

Thermostats available from EMI

EMI offers a thermostat that is compatible with your PTAC/PTHP unit.

- Select EMI part number 240008208 from the latest RetroAire price list for this option. This is a single stage, cool/heat, thermostat that can be used in all RetroAire cooling, heating or heat pump applications.
- The thermostat has an adjustable setpoint range of between 45°F(7°C) and 90°F(32°C).
- For heat pumps another option is EMI part number 240008209. This is a 2 stage heat/cool thermostat which allows for emergency heat.

Selecting a thermostat (by others)

When selecting a thermostat other than one offered by EMI, choose a single stage heat/cool, 24v thermostat.

Straight cooling with electric heat or hydronic heat **(R10C — PTAC's)**

Select a thermostat that is compatible with a cooling/electric heat system.

The thermostat should have "R", "Y", "W", "C" and "G" terminals.

Heat pump with electric heat (R_H - PTHPs)

Select a thermostat that is compatible with a cooling/single-stage heat/heat pump system.

The thermostat should have "R", "Y", "O" and "G" terminals. RetroAire units are single stage heating only.

The electric heat and heat pump will not operate simultaneously.

Preparing for the Installation of the PTAC/PTHP

WARNING

Moving parts can cause personal injury. Avoid contact with moving parts when testing or servicing the unit.

Verify existing wall sleeve/enclosure:

RetroAire replacement PTAC/PTHP's are to be used with metal wall sleeves.

The existing front panels must be secured by screws that prevent contact with all parts.

Minor dimensions of openings must not exceed ½ inch (12.5mm).

The indoor air discharge grill must have dimensions not less than 26" x 4". The grill must separate the top surface of the chassis from the top surface of the discharge grill by a minimum of 1 in (25.4mm).

For all models, the outdoor openings must prevent contact of all moving parts by means of louvers or grills, with minor dimension not exceeding 1 in (25.4mm).

Electrical supply

Each unit must have a separate branch circuit protected by a fuse or breaker. Refer to the unit rating plate for the proper wire and breaker or fuse size. Use of extension cords is prohibited.

DO NOT connect the RetroAire unit to a circuit with an incorrectly-sized overcurrent-protection device.

All cord-connected 265-volt units must be plugged into receptacles within the unit subbase or chassis.

Electrical shock hazard — Before opening the existing unit:

Open the power supply disconnect switch. Secure it in an open position during installation. Attach a sign stating, "**DO NOT TURN ON.**"

On a plug and receptacle connection, unplug the existing unit at the wall outlet. DO NOT plug in the new unit until installation is complete and the start-up checklist has been completed.

Failure to comply with the above could result in severe personal injury, death or substantial property damage.

NOTICE

All wiring should be in accordance with both the National Electric Code (NEC) and the local building codes.

UNITS RATED 208/230V — the RetroAire unit is wired for 230v primary voltage from the factory. The transformer must be rewired by the installer if the jobsite voltage is 208v. Change the transformer tap from orange to red. See the wiring diagram for details.

Electrical power connection

1. Check the RetroAire unit rating plate for circuit ampacity and required breaker or fuse size.
2. Verify that the existing breaker or fuse is the correct size.
 - a. Replace the breaker or fuse if incorrectly-sized.
 - b. **Breakers must be type HACR only.**
3. Cord-connected units — verify that the wall outlet is the correct rating. The outlet's blade configuration must match that of the cord supplied with the RetroAire unit.
4. Hard-wired units — verify that the power wiring is correctly sized. Inspect the existing wiring for any deficiencies, such as cuts or frayed wires. Replace such wiring if found.

Remove the old chassis

1. Disconnect power or unplug cord before proceeding. See **WARNING** at left.
2. Remove the front of the existing room enclosure to expose the old chassis.
3. Loosen any tie-down bolts or screws and remove the old chassis.

NOTICE

Dispose of the old chassis following existing state and federal regulations.

4. Inspect the wall sleeve/cabinet for any rust, holes, or damage.
 - a. Clean the wall sleeve of any dirt.
 - b. Repair any damage.
 - c. Ensure proper drainage of condensate or rainwater to exterior of building.
5. Remove or repair the old weather seals and make note of the location for the installation of any new seals.
6. Check the wall sleeve/cabinet to ensure all drain holes are open and that:
 - a. The wall sleeve/enclosure is level left to right
 - b. The back is pitched to the outside by ½in (12.5mm) maximum.
7. Before installing the new chassis, inspect the outdoor louver for a minimum free area of 70% and remove any obstructions. Obstructions will restrict air flow over the condenser coil and may cause serious damage to the chassis. It will also void the warranty.
8. See the instructions for the specific RetroAire unit on the following pages.
9. **DO NOT** connect power to the unit or plug in the cord until all instructions in this manual have been followed.

Installation Instructions — R30C | R30H

Installation

1. **Verify the existing wall thickness** — The distance from the condenser coil to the outdoor louver varies with sleeve depth, unit(s) ship standard with 1 3/8" (35mm) & 1 1/2" (38mm) baffles. In addition, EMI stocks an optional condenser-side air baffle kit for chassis installation in deeper-than-standard wall sleeves. For fast, trouble-free installation, know your wall sleeve depth when ordering.
2. **Install the baffles** — Slide the unit back out of the wall sleeve. Remove both sets of baffles from the kit bag supplied with unit. Install only one set of left and right side baffles on the condenser coil by completing steps below:
 - Choose the proper fitting baffles for your application by verifying selected baffles come in contact with the outdoor louver.
 - Make sure the baffles are directed inward toward the center of coil.
 - Secure baffles tightly into the existing holes of the condenser coil using the screws provided.

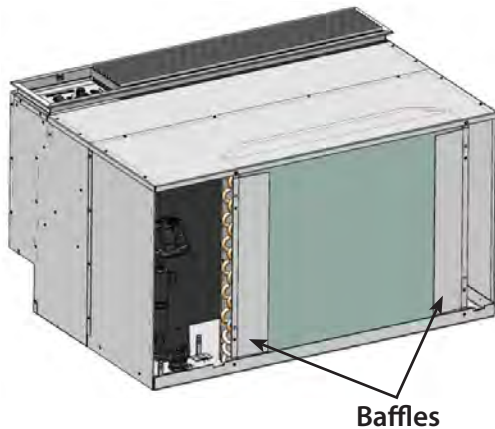

NOTICE

The correct condenser air baffles must be installed or performances may be impaired.

3. **Install the foam tape** — Apply one piece of 1/2" x 1/2" open-cell poly-foam to top flange of evaporator block off.
4. **Install the foam tape** — Apply 2" x 1/2" open-cell foam strips around supply air duct to ensure that all the conditioned air is delivered into the room. Failure to do so results in recirculation of the conditioned air through the cabinet causing the unit to short cycle and coil to freeze.

Installation kit contents

- Installation manual

Optional hydronic Heat Controls

- (1) 2-position connector
- (1) Pin mate

5. **Connecting the optional hydronic coil controls** — If the hydronic heat option has been ordered, then the hydronic coil will need to be field installed on the new unit. Hydronic coils are not factory installed and need to be ordered. The coil with the old unit can be located in the subbase, under the chassis in a special attachment, or above the chassis in a special attachment. It is necessary to know where the coil is to be located and the physical size of the coil so the new coil can be verified if ordered for replacement. The new coil should be installed in the same manner as the coil it is replacing.
 - Remove the 2-position connector assembly from kit bag supplied with unit (*this will have 2 yellow wires attached*).
 - Connect this 2-position connector to the 2-position connection located on the bottom of the control box panel.
6. **Connecting the accessory Aquastat** — If the accessory Aquastat has been ordered then it will need to be field installed.
 - Remove the black jumper wire located on the bottom panel of the control box (*this is also terminated with a 2-position connector*).
 - Cut the jumper wire in the middle and splice the Aquastat to the jumper.
 - Place the connector back into original location. Refer to the wiring diagram on the unit for details.
7. **Secure the chassis** — Ensure all seals are in the proper locations, the correct baffles are attached to the condenser coil, and in the proper orientation, then slide the unit into final position and tighten any tie down bolts or screws as necessary.
8. **Hard-wired units** — If the unit is hard wired, follow the instructions on pages 10 to 12 to verify existing wiring and overcurrent protection. Remove the line cord wires from the PTAC/PTHP power entrance terminals. Route the power supply wiring through a strain-relief bushing and connect leads to the power entrance terminals. Secure the strain-relief clamp. (If wiring is through conduit, insert the conduit through the control box knockout and secure in place.) **DO NOT** turn on power until completing instructions in "Final Inspection and Startup" on page 13.
9. **DO NOT PLUG IN the line cord, if in used condition.** Follow instructions in "Final Inspection and Startup" on page 13.

Sequence of Operation

The following Sequence of Operation applies to PTAC/PTHP units.

The **R__C** units are straight cool, single stage air conditioners available with electric or hydronic heat.

The **R__H** units are limited range, single stage heat pump. Mechanical compression heating (heat pump mode) is locked out at outdoor temperatures of approximately 35 °F (1.7 °C) and below. Below these ambient temperatures, the auxiliary electric or hydronic heat will be used.

General

The unit is controlled by a microprocessor. Thermostat and control connections are made to the control board.

Figure 3 - Control Board

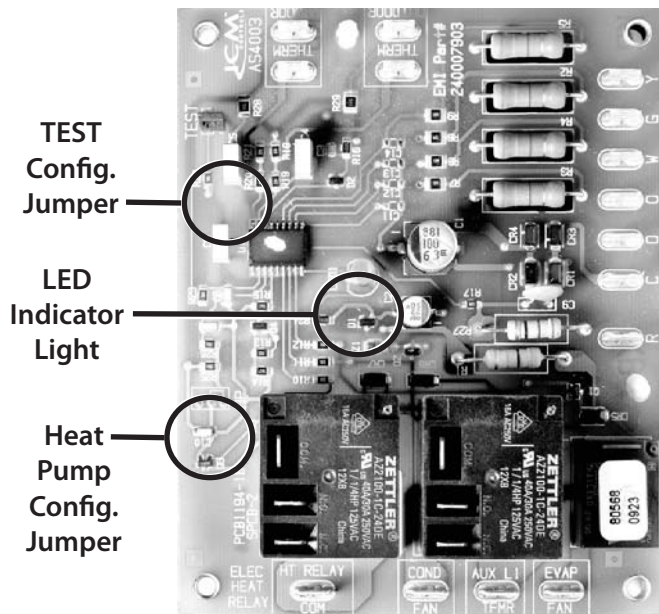

Two configuration jumpers are located on the board, see Figure 8. The Heat Pump Configuration Jumper is a 3 pin jumper.

- Straight **Cool** units **R__C**, the jumper should be located on the outside two pins.
- **Heat Pump** units **R__H**, the jumper should be located on the inside two pins.

A second configuration jumper “TEST” allows for the control’s internal timers to be by-passed for test purposes. Placing the jumper on the two pins enables the test mode.

A status LED (Light Emitting Diode), LED1 is located on the center of the board. A series of blinks communicates the status of the board. Between the blink sequence is a separation of approximately 2 seconds. The Status Code is listed below.

Trouble Code (Blinks)	Status
1	Normal Operation
2	Anti-Short Cycle Timer Active
3	Outdoor Coil Freeze Protection
4	Indoor Coil Freeze Protection
5	Simultaneous “Y” and “W” Call

Initial Power-Up or Power Restoration

When power is applied to the unit, either for the first time or after a power failure, the board will initialize itself. During the initialization, LED1 will be lit continuously for approximately 5 seconds. Following the initialization, a random start timer is initiated. This timer adds a randomly selected 5-120 seconds to the start-up sequence, reducing the possibility of multiple units starting at the same time. Once the random start timer has expired, a 180 second Anti-Short Cycle Timer is initiated and the Processor Board Trouble Code LED is set to blink a 2 flash code. This timer prevents the compressor from rapid cycling. After the Anti-Short Cycle Timer expires, the Processor Board Trouble Code LED is set to blink a 1 blink Trouble Code, indicating normal operation.

R__C / R__H; Cooling Operation

(For unit mount controls)

With the System Switch [SS] set to “Cool”, and the Fan Cycle Switch [FCS] set to “On” (Continuous Fan Operation), the indoor fan motor will start. If the Fan Cycle Switch [FCS] is set to “Off” (Cycling Fan Operation), the indoor fan motor will start with a call for cooling from the internal thermostat [T’sat]. If the unit is equipped with a Motorized Fresh Air Damper, and is active with the Fresh Air Switch [FAS], the damper will open with a call for the indoor fan. If the room temperature is below the thermostat setting the fan operation will continue as noted above. If the room temperature is above the thermostat setting, the reversing valve will be energized, the compressor and outdoor fan will start provided the Anti-Short Cycle Timer has timed out from the initial power-up, power restoration or a previous compressor on cycle. Operation will continue until the room temperature satisfies the thermostat. Once the room temperature falls below the set point by 3 °F (2 °C), the compressor, outdoor fan motor and reversing valve will de-energize. If the FCS is set to “Off”, the indoor fan will continue to operate for 60 seconds after the compressor stops. If the FCS is set to “On”, the indoor fan will continue to operate. As soon as the compressor is de-energized, the Anti-Short Cycle Timer will be initialized and will prevent the compressor from starting again for another 180 seconds. While the Anti-Short Cycle Timer is active, the Processor Board Trouble Code LED is set to blink a 2 flash code. After the Anti-Short Cycle Timer expires, the Processor Board Trouble Code LED is set to blink a 1 blink Trouble Code, indicating normal operation.

Sequence of Operation *(continued)*

NOTE:

- Remote-Mount Cooling Operation depends on the features of the wall-mounted thermostat. By default the fan will cycle with a call for cooling. For thermostats with an **AUTO / ON** fan switch, the fan will run continuously if this is “ON” (Continuous Fan Operation). The fan will cycle with a call for cooling if this is set to “AUTO” (Cycling Fan Operation).
- In cooling the units will not start if the indoor air temperature is 60°F (15.5 °C) or below or if the outdoor temperature is below 40°F (4.5°C).

R__C / R__H; Heating Operation

With the System Switch [SS] set to “Heat”, and the Fan Cycle Switch [FCS] set to “On” (Continuous Fan Operation), the indoor fan motor will start. If the Fan Cycle Switch [FCS] is set to “Off” (Cycling Fan Operation), the indoor fan motor will start with a call for heating from the internal thermostat [T’sat]. If the unit is equipped with a Motorized Fresh Air Damper, and is active with the Fresh Air Switch [FAS], the damper will open with a call for the indoor fan. If the room temperature is above the thermostat setting the fan operation will continue as noted above. If the room temperature is below the thermostat setting, the action of the unit will depend on the outdoor temperature and the freeze sensor status.

NOTE: Remote-Mount Heating Operation depends on the features of the wall-mounted thermostat. By default the fan will cycle with a call for Heating. For thermostats with an **AUTO / ON** fan switch, the fan will run continuously if this is “ON” (Continuous Fan Operation). The fan will cycle with a call for heating if this is set to “AUTO” (Cycling Fan Operation).

• R__H; Mechanical Heating “Heat Pump”

”If the outdoor coil temperature remains above 25 °F (-4 °C), the compressor and outdoor fan will start provided the Anti-Short Cycle Timer has timed out from the initial power-up, power restoration or a previous compressor on cycle. Operation will continue until the room temperature satisfies the thermostat. Once the room temperature rises above the set point by 3 °F (2 °C), the compressor and outdoor fan motor will de-energize. If the FCS is set to “Off”, the indoor fan will continue to operate for 60 seconds after the compressor stops. If the FCS is set to “On”, the indoor fan will continue to operate. As soon as the compressor is de-energized, the Anti-Short Cycle Timer will be initialized and will prevent the compressor from starting again for another 180 seconds. While the Anti-Short Cycle Timer is active, the Processor Board Trouble Code LED is set to blink a 2 flash code. After the Anti-Short Cycle Timer expires, the Processor Board Trouble Code LED is set to flash a 1 blink Trouble Code, indicating normal operation.

• R__H; Auxiliary Heating “Electric” or “Hydronic”

If the outdoor coil temperature falls to 25 °F (-4 °C) or below for 180 seconds at anytime during a heating call, the compressor and outdoor fan motor will be de-energized and auxiliary heat will be energized. The Anti-Short Cycle Timer will be initiated, prohibiting compressor operation for 180 seconds. The Processor Board Trouble Code LED will flash a 3 blink Trouble Code, indicating auxiliary heat operation. Heating operation

with auxiliary heat will continue until the outdoor coil sensor reaches 50 °F (10 °C).

• “Electric Heat”

With the System Switch [SS] set to “Heat”, and the Fan Cycle Switch [FCS] set to “On” (Continuous Fan Operation), the indoor fan motor will start. If the Fan Cycle Switch [FCS] is set to “Off” (Cycling Fan Operation), the indoor fan motor will start with a call for heating from the internal thermostat [T’sat]. If the unit is equipped with a Motorized Fresh Air Damper, and is activated with the Fresh Air Switch [FAS], the damper will open with a call for the indoor fan. If the room temperature is above the thermostat setting the fan operation will continue as noted above. If the room temperature is below the thermostat setting, the electric heater is energized until the room temperature satisfies the thermostat. Once the room temperature increases above the set point by 3 °F (2 °C), the electric heaters will de-energize.

• “Hydronic Heat”

If the FCS is set to “On” (Continuous Fan Operation) and the unit has an AquaStat, the indoor fan and fresh air motorized damper operation will be controlled by the Aquastat. If the AquaStat senses a temperature of 80 ± 5 °F (26 ± 3 °C) or below, the indoor fan will shut down and the motorized damper will close fresh air door. With a call for heat, a signal from the processor board will activate the water or steam valve. If the unit is equipped with a field installed AquaStat [AS], the indoor fan start will be delayed until the hydronic coil reaches 100 ± 5 °F (38 ± 3 °C). The signal to the water or steam valve will continue until the room temperature rises above the set point by 3 °F (2 °C). If the FCS is set to “Off”, the indoor fan will continue to operate for 60 seconds or until the hydronic coil temperature as sensed by the AquaStat reaches 80 ± 5 °F (26 ± 3 °C), whichever occurs first. If the FCS is set to “On”, the indoor fan will de-energize if the AquaStat senses a temperature of 80 ± 5 °F (26 ± 3 °C) or below.

• “Remote Wall Thermostat Controls”

Cooling and Heating operates identical to unit mount controls. See remote controls manual for control details. Remote units do not use a system switch, or FCS.

Final Inspection & Start-up

Before operating the unit

- Read and understand the contents of this manual.
- Install the unit per the instructions outlined in this manual and all applicable local and national codes.
- Ensure the electrical supply matches the electrical requirements of the unit, and that the unit is properly grounded.
- Examine control box. Ensure all wire connections are secure, and that control board jumpers are in the proper positions. See “” on page 14.
- Verify that the chassis is properly fitted to the wall sleeve and securely mounted to the surrounding framing.
- Make sure the chassis is level:
 - Pour water into the drain pan.
 - Make certain it flows through the drain hoses to the condenser side of the unit.
- Verify that indoor blower wheels and outdoor fan blades are secured to their motor shafts, and rotate freely.
- Ensure all sheet metal panels are in place and secure.
- Attach the front panel to the existing cabinet enclosure.
- Verify that nothing will interfere with the room discharge air or the return air of the units. Examples:
 - Check for curtains or drapes that obstruct the air flow.
 - See Figure 4 and Figure 5.
 - Check for plush carpeting that can obstruct the return air.
 - Items like these can cause serious damage to the chassis.

CAUTION

Any obstruction of supply air, including the use of deflector baffles, may cause condensate to form on the louver or cabinet (see Figure 4).

Figure 4 Proper air flow diagram



To ensure optimum performance of your PTAC/PTHP, avoid restricting the air flow. The position of curtains or drapes over supply air grille may cause air to recirculate without cooling the room. The unit will short cycle and may cause premature compressor failure (see Figure 5).

Figure 5 Restricted air flow diagram



Final Inspection & Start-up *(continued)*

NOTICE

All wiring should be in accordance with both the National Electric Code (NEC) and the local building codes.

UNITS RATED 208/230V — the RetroAire unit is wired for 230v primary voltage from the factory. The transformer must be rewired by the installer if the jobsite voltage is 208v. Change the transformer tap from orange to red. See the wiring diagram for details.

Setting the control board jumpers

The control board has two sets of factory installed jumper pins on the control board, **HP** jumper and **TEST** jumper. These pins have

HP jumper — to select heat pump or straight cooling

These pins determine whether the unit operates as straight cooling or as heat pump (see Figure 6 and Figure 8).

- Jumper the right pin to the center pin for heat pump operation.
- Jumper the left pin to the center pin for straight cooling operation.

Figure 6 HP Jumper *(selects heat pump or straight cooling)*

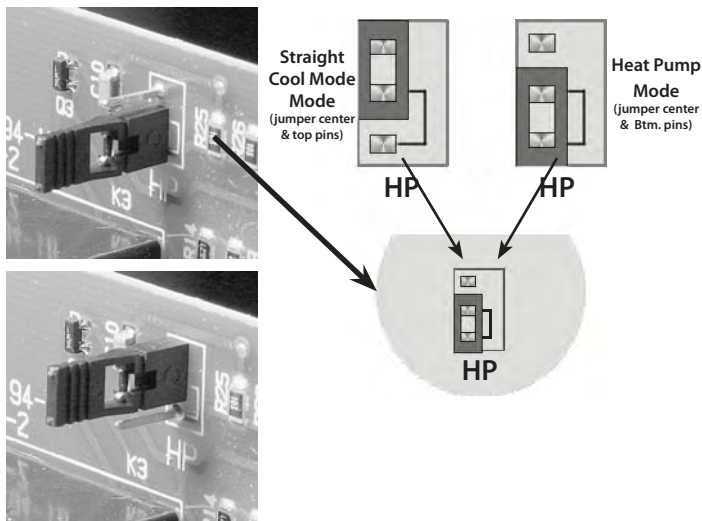

TEST jumper— to select normal or test mode

This jumper is for use in testing only (see Figure 7 and Figure 8).

When the **JUMPER** pins are jumpered together, all timers are eliminated (*example — anti-short cycle, purge, etc.*). This is mainly used for production line testing. But it may be used for field testing as well. The units are factory set with the jumper on only one pin (*normal operation position*).

⚠ WARNING

Do not leave the unit operating with the TEST jumper in the TEST position.

Figure 7 TEST jumper *(selects normal or test mode)*

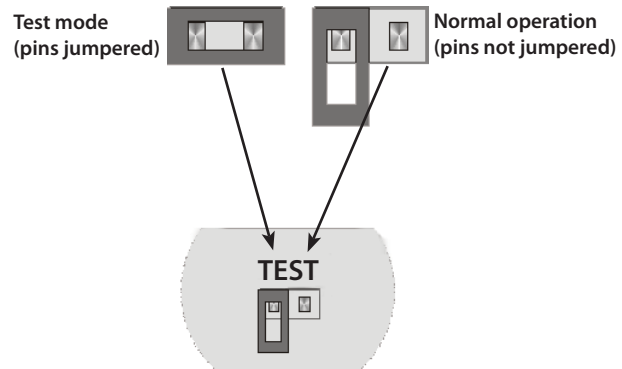
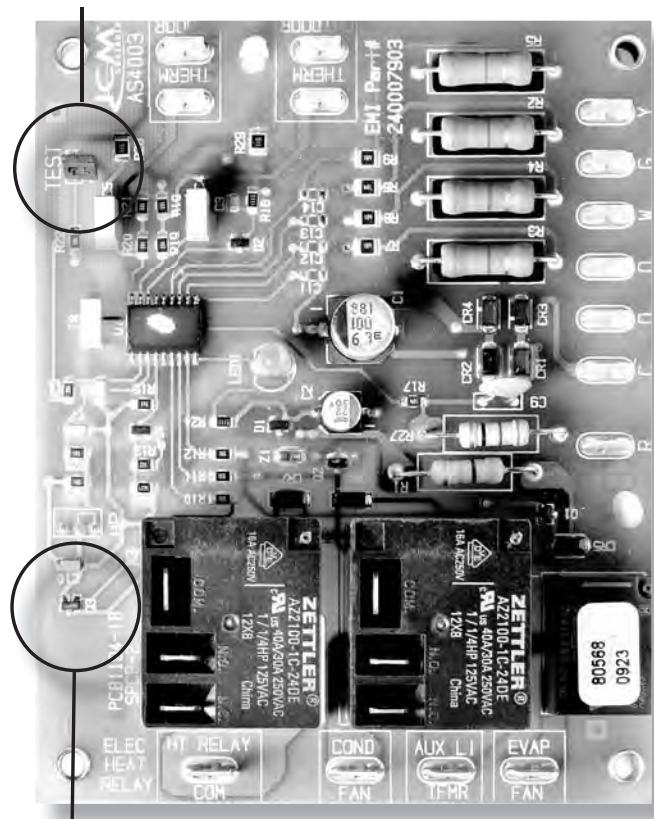

Figure 8 Circuit board

TEST JUMPER



HEAT PUMP JUMPER

Final Inspection & Start-up *(continued)*

Start Up

1. Ensure the unit is secure and level.
2. **Heat pump units only** — Verify that the thermostatic drain pan valve is operating correctly. The valve should be closed if the temperature is above 60°F and open if the temperature is below 60°F.
3. If equipped, test the fresh air damper by setting the damper door switch to the **"YES"** position and verify the damper opens and allows fresh air to be moved into the space. Then, set the damper door switch to the **"NO"** position, and verify the flow of air into the space has stopped. Fresh air will only be available when the indoor fan is running.
4. Verify that the **HP** jumper is set correctly for the unit type — cooling only or heat pump unit (see Figure 6, page 14).
5. Set the **TEST** jumper to **test mode** if desired. This will disable time delays, including anti-short-cycle and purge times (see Figure 7, page 14).
6. Verify that the unit is wired according to instructions in this manual, including requirements on page 13.
7. Connect Electric power to the unit .
8. Turn on the unit to check for proper operation. Check condensate removal by pouring water into the base pan, putting the unit in cooling mode, and with the condenser fan running, seeing if water is picked up by the slinger ring and thrown onto the outdoor coil.

NOTICE

The compressor will not start until the anti-short time period has elapsed. On power-up, there will also be delays for control board initialization and random-start timing. See "Sequence of Operation" on page 11.

Unit-mounted thermostat

1. Use the system switch to place the PTAC/PTHP in either the **COOL**, **HEAT**, or **OFF** position (see Figure 9). Test operation in all positions.
2. Use the fan speed switch places the fan in either **LOW** or **HIGH** speed (see Figure 9). Test operation in both positions for heating and cooling.
3. Test operation of the Fan Cycle switch (this is a toggle switch on side of control box), with switch set at ON (continuous fan operation) or AUTO (cycling with thermostat) for both heating and cooling. Set the switch in the desired position.
4. Rotate the thermostat knob to the left to increase setpoint temperature, or to the right to decrease (see Figure 9). Turning the unit-mounted thermostat knob to the far left will produce the warmest room temperature, while turning it all the way to the right will produce the coolest. The setting can be adjusted for personal comfort.

Figure 9 Typical Representation of a Unit Mount Control

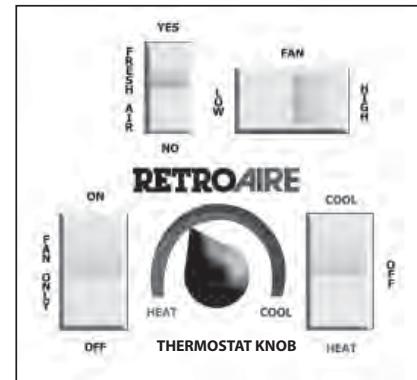

! CAUTION

DO NOT rotate the thermostat knob back and forth from heating to cooling. This causes the compressor to cycle on and off rapidly and will cause damage to the compressor. Allow the compressor to remain off for at least three minutes prior to restarting the unit.

Remote-mounted thermostat

1. Use the thermostat to place the PTAC/PTHP in either the **COOL**, **HEAT**, or **OFF** position. Test operation in all positions.
2. If the thermostat is fitted with a fan switch, set as desired places the fan in either **ON**, **OFF**, or **AUTO**. Test operation in all positions.
3. Check thermostat calibration for both heating and cooling operation.

Straight cooling PTAC's

Cooling cycle

1. Place the thermostat or system switch in the **COOL** position.
2. Adjust the thermostat to a cooler temperature until the indoor fan starts running. The compressor and outdoor fan should then turn on and cold air will begin to flow from the unit. Let the unit continue operating to cool the room and remove humidity.
3. After the unit starts running and the space gets cooler, adjust the thermostat to a warmer temperature until the compressor cycles off.
4. If a colder room temperature is desired, adjust the thermostat to a cooler temperature setting, turning the compressor and both fans back on.
5. If a warmer room temperature is desired, adjust the thermostat to a warmer temperature setting. The compressor and outdoor fan will stop and the indoor fan will switch off after the sixty-second purge time has elapsed.
6. Place the thermostat or system switch in the **OFF** position. All operation should stop.

Final Inspection & Start-up *(continued)*

NOTICE

The room temperature must be above 65°F (18°C) for the compressor to operate in cooling mode on PTAC's with unit-mounted controllers.

CAUTION

When the unit is first powered up, high humidity conditions can cause condensation to form on the discharge grill. Keep doors and windows closed to reduce humidity and condensation will evaporate.

Heating cycle — electric option

1. Place the thermostat or system switch in the **HEAT** position.
2. Adjust the thermostat for a warmer temperature until the indoor fan starts running and the electric heater coil starts emitting heat.

NOTICE

The outdoor fan does not run during the heating cycle.

3. After the unit starts running and the space gets warmer, adjust the thermostat to a cooler temperature until the electric heater turns off.
4. If a warmer room temperature is desired, adjust the thermostat to a warmer temperature setting, which will turn the electric heater back on.
5. If a cooler room temperature is desired, adjust the thermostat to a cooler temperature setting until the electric heater turns off. The indoor fan will switch off after the sixty-second purge time has elapsed.
6. Place the thermostat or system switch in the **OFF** position. All operation should stop.

NOTICE

Room temperature must be below 85°F (29.4°C) to energize the heater on PTAC's with unit-mounted controllers.

Heating cycle — hydronic option

NOTICE

Make sure the motor valve is rated for the correct voltage. Most RetroAire units with unit mount controls will power a hydronic valve that is the same voltage as the unit (ex: a unit rated 208/230v will power a 208/230v). A switch is provided on the control box to change from NO to NC. Be sure to check the wiring diagram (located on the unit) and voltage application for the specific unit. Other valve configurations and voltage options are available. Consult Technical Service if the unit voltage does not match your valve application.

1. Place the thermostat or system switch in the **HEAT** position.
2. Adjust the thermostat to a warmer temperature. The following should then occur:
 - A signal from the processor board will activate the water or steam valve.
 - The motorized valve should open and allow hot water or steam to run through the coil.
 - The indoor fans will run, blowing air through the hydronic coil. If the unit is equipped with an Aquastat, the indoor fan and the motorized damper operation will be delayed until the hydronic coil reaches 100 ± 5°F (38 ± 3°C).
 - The signal to the water or steam valve will continue until the room temperature rises above the setpoint by 3°F (2°C).
3. After the unit starts running and the area gets warmer, adjust the thermostat to a cooler temperature, the hydronic valve will close and indoor fan will switch off after the sixty-second purge time has elapsed.
4. If a warmer room temperature is desired, adjust the thermostat to a warmer temperature setting, which will open the hydronic valve and turn on the indoor fan.
5. If a cooler room temperature is desired, adjust the thermostat to a cooler temperature setting. The hydronic valve will again close and indoor fan will switch off after the sixty-second purge time has elapsed.
6. Place the thermostat or system switch in the **OFF** position. All operation should stop.

NOTICE

Room temperature must be below 85°F (29°C) for the hydronic heater to operate on PTAC's with unit-mounted controllers. The hydronic valve is a 24Vac normally open valve. Should power be interrupted, the valve will default to the open position.

Completion of testing for cooling-only PTAC's

Operation testing is now complete. If **TEST** jumper was set to **test mode** then make sure to set it back to **normal operation** (see Figure 7, page 14).

WARNING

Do not leave the unit operating with the TEST jumper in the TEST position. Prolonged operation with the unit on test mode will cause damage to the internal components of the unit.

Heat Pump PTHP's

NOTICE

The unit is equipped with a reversing valve that is energized for cooling and de-energized in heating mode.

Cooling cycle — heat pump units

1. Place the thermostat or system switch in the **COOL** position.
2. Adjust the thermostat to a cooler temperature until the indoor fan

Final Inspection & Start-up *(continued)*

starts running. The compressor and outdoor fan should then turn on and cold air will begin to flow from the unit. Let the unit continue operating to cool the room and remove humidity.

3. After the unit starts running and the space gets cooler, adjust the thermostat to a warmer temperature until the compressor cycles off.
4. If a colder room temperature is desired, adjust the thermostat to a cooler temperature setting, turning the compressor and both fans back on.
5. If a warmer room temperature setting is desired, adjust the thermostat to a warmer temperature. The cooling mode will cease and the compressor and outdoor fan will stop. The indoor fan will switch off after the sixty-second purge time has elapsed.
6. Place the thermostat or system switch in the **OFF** position. All operation should stop.

NOTICE

The room temperature must be above 65°F (29°C) for the compressor to operate in cooling mode on PTHP's with unit-mounted controllers.

7. Place system switch in the **OFF** position. All operation should stop.
- Heating operation — heat pump units — outdoor temperature above 40°F (4°C)**

1. Place the thermostat or system switch in the **HEAT** position.
2. Adjust the thermostat to a warmer temperature setting until the indoor fan start running. The compressor and outdoor fan should then turn on and warm air will begin to flow from the unit.
3. After the unit starts running and the space gets warmer, adjust the thermostat to a cooler temperature until the compressor cycles off.
4. For a warmer room temperature, adjust the thermostat to a warmer temperature setting turning the indoor and outdoor fans, and compressor back on.
5. If a cooler room temperature is desired, adjust the thermostat to a cooler temperature setting. The heating mode will cease and the compressor and outdoor fan will stop. The indoor fan will switch off after the sixty-second purge time has elapsed.

NOTICE

Room temperature must be below 85°F (29°C) for the compressor to operate in heating mode on PTHP's with unit-mounted controllers. .

6. Place the thermostat or system switch in the **OFF** position. All operation should stop.

NOTICE

Heat pump units are “Limited Range” equipped with back-up electric resistance heat. Limited Range heat pumps are designed to operate when outdoor temperatures are between 75°F (24°C) and 40°F (4°C) and with a maximum indoor temperature of 85°F (29°C). When the outdoor temperature falls below approximately 40°F (4°C) the unit will switch from heat pump to electric resistance heat, or hydronic heat if optionally added. Electric heat or hydronic heat will then remain as the heat source until the outdoor temperatures rise above 50°F (10°C). RetroAire heat pumps (R__H) are single-stage heating units. The electric heat and heat pump will NOT operate simultaneously.

Auxiliary heating operation — heat pump units — outdoor temperature below 40°F (4°C) — electric option

1. Place the thermostat or system switch in the **HEAT** position.
2. Adjust the thermostat to a warmer temperature until the indoor fans start running and the electric coil starts emitting heat.
3. After the unit starts running and the space gets warmer, adjust the thermostat to a cooler temperature until the electric heater turns off.
4. If a warmer room temperature is desired, adjust the thermostat to a warmer temperature setting, which will turn the electric heater back on.
5. If a cooler room temperature is desired, adjust the thermostat to a cooler temperature setting until the electric heater turns off. The indoor fan will switch off after the sixty-second purge time has elapsed.
6. Place the thermostat or system switch in the **OFF** position. All operation should stop.

Final Inspection & Start-up *(continued)*

NOTICE

Room temperature must be below 85°F (29°C) to energize the heater on PTHP's with unit-mounted controllers.

5 kW heat models only — in the event the limit switch opens and de-energizes the electric heat, the limit switch will need to be manually reset.

To reset switch:

- Turn power off
- Remove the control box cover.
- Locate the limit switch.
- Push in the reset button on the face of the switch (see Figure 10).

Auxiliary heating operation — heat pump units — outdoor temperature below 40°F (4°C) — hydronic option

1. Place the thermostat or system switch in the **HEAT** position.
2. Adjust the thermostat to a warmer temperature.
The following should then occur:
 - A signal from the processor board will activate the water or steam valve.
 - The motorized valve should open and allow hot water or steam to run through the coil.
 - The indoor fans will run, blowing air through the hydronic coil
 - If the unit is equipped with an Aquastat, the indoor fan and the motorized damper operation will be delayed until the hydronic coil reaches 100 ± 5°F (38 ± 3°C).
 - The signal to the water or steam valve will continue until the room temperature rises above the setpoint by 3°F (2°C).
 - After the unit starts running and the space gets warmer, the hydronic valve will close and indoor fan will switch off after the sixty-second purge time has elapsed.
3. After the unit starts running and the space gets warmer, adjust the thermostat to a cooler temperature setting, the hydronic valve will close and indoor fan will switch off after the sixty-second purge time has elapsed.
4. If a warmer room temperature is desired, adjust the thermostat to a warmer temperature setting, which will open the hydronic valve

and turn on the indoor fan.

5. If a cooler room temperature is desired, adjust the thermostat to a cooler temperature setting. The hydronic valve will again close and indoor fan will switch off after the sixty-second purge time has elapsed.
6. Place the thermostat or system switch in the **OFF** position. All operation should stop.

NOTICE

Room temperature must be below 85°F (29°C) for the hydronic heater to operate on PTHP's with unit-mounted controllers. The hydronic valve is a 24Vac normally open valve. Should power be lost to the unit, the valve will default to the open position.

Completion of testing for heat pumps

Operation testing is now complete. If the **TEST** jumper was set to **test mode** then make sure to set it back to **normal operation** (see Figure 7, page 14).

Maintenance & Troubleshooting

Monthly inspection and maintenance

⚠ DANGER

Electrical shock hazard — disconnect power to the RetroAire replacement PTAC/PTHP before servicing or accessing the control compartment. Failure to do so could result in severe personal injury or death.

⚠ WARNING

It is illegal to discharge refrigerant into the atmosphere. Use proper reclaiming methods and equipment when servicing a RetroAire replacement PTAC/PTHP.

For optimum performance and reliability of your RetroAire replacement PTAC/PTHP, ECR International recommends performing the following inspections and maintenance on a monthly basis. Units that are installed in harsh or dirty environments will require more frequent inspections and maintenance.

Disconnect power to unit and remove necessary access panels.

- Clean or replace the indoor air filter.
- Vacuum return air grille surface.
- Inspect & clean the chassis interior for rodent or insect infestation.
- Clean & flush condensate drain pan and chassis base pan.
- If applicable, ensure the condensate drain is functioning properly.
- Inspect refrigeration tubing, especially braze joints, for signs of refrigerant leaks (*oil residue*). Repair if necessary.
- Inspect indoor and outdoor coils. Ensure dirt or debris have not collected on the fins. Clean if necessary. Be careful not to damage coil fins when cleaning. Use a fin comb to straighten any bent fins.
- Examine control box. Ensure all wire connections are secure.
- Ensure indoor blower wheels and outdoor fan blades are secured to their motor shafts.
- Ensure dirt or debris have not collected on the indoor blower wheels and outdoor fan blades. Use a vacuum and soft brush to clean if necessary.
- If the unit has a hydronic option installed, inspect piping, especially braze joints, for signs of water leaks. Repair if necessary.
- Clean the exterior of the cabinet as desired with a mild soap or household cleaner.
- 5 kW heat models only** — in the event the limit switch opens and de-energizes the electric heat, the limit switch will need to be manually reset.

To reset switch:

- Remove the control box cover.
- Locate the limit switch.
- Push in the reset button on the face of the switch (see Figure 10).

Figure 10 Manual Reset Limit Switch

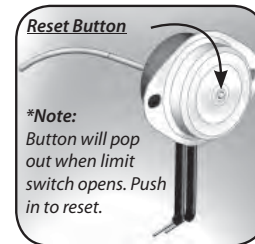

⚠ WARNING

Clean or replace the return air filter as needed. Allowing dust to collect on the filter will cause the unit to lose efficiency and eventually malfunction. Check the filter at least once a month. Some environments may require more frequent replacement, depending on particulate in the air stream.

NOTICE

If a new air filter is needed for your RetroAire replacement PTAC/PTHP, consult factory for availability and/or proper sizing.

Seasonal start-up and maintenance

At the beginning of the cooling and heating seasons, a complete mechanical check should be performed and maintenance/inspections performed as described below.

Disconnect power to unit and remove necessary access panels.

1. Performing the inspections and maintenance defined in "Monthly start-up and maintenance."
2. Do a visual check of the equipment. Look for obvious changes in the unit such as damaged coils or evidence of extended wear on any moving parts.
3. Check for unusual odors, oil leaks, or stains on or around the coil and refrigerant lines. The presence of oil here may indicate a potentially serious problem such as a refrigerant leak (*example — burned motor windings, water, or refrigerant*).
4. Make sure the base pan is clean.
5. Inspect all electrical connections. Look for frayed wires and poor connections. Terminal ends that are loose will eventually fail, causing a loss of performance or worse.
6. Check fan motors and blower assemblies. Some units may require a drop of light oil to motors and/or bearing assemblies (*look for oil cups*). Ensure setscrews and motor mounting hardware are tight.
7. Brush and/or vacuum the centrifugal fan blades and blower cage assemblies, as they must be clean to operate efficiently.
8. Inspect both indoor and outdoor coils. Use a fin comb to straighten out any damaged fins. These coils must be clean for proper operation.

⚠ WARNING

Do not use a solvent-based cleaner to clean coils, as some solvents will produce a noxious odor when the unit is in operation.

Maintenance & Troubleshooting *(continued)*

9. Look for oil leaks or stains on or around all braze joints and refrigerant lines. The presence of oil here indicates a potentially serious problem (*such as a refrigerant leak*).
10. Inspect and clean the drain pan and drain line(s). The use of an anti-fungicide tablet to keep the condensate system free from bacterial contaminants is recommended.
11. Check the pitch of the unit. Over time the building and equipment may settle, causing a shift in the direction of the condensate flows. Ideally the unit should pitch a minimum of 5° (*at least ½"*) to the outside to allow for proper drainage.
12. Check weep holes along rear flange of the base pan to ensure they are free of debris.
13. Check to ensure the seal around the unit is not broken or damaged.

NOTICE

Air leaks may make the conditioned area uncomfortably drafty or produce noises. Visually inspect the foam gasket between the wall and the unit, especially taking note of the separation between the air inlet for the condenser and the condenser coil discharge. These two areas must be sealed off from each other. If you experience poor cooling operation or erratic operation, check for air recirculation at the condenser coil.

14. Replace the access panels and reconnect the electrical power.
15. Test the unit operation.

Heat pump units — temporary emergency heating mode

⚠ DANGER

Electrical shock hazard — Disconnect power to the RetroAire replacement PTAC/PTHP before servicing or accessing the control compartment. Failure to do so could result in severe personal injury or death.

Should the heat pump fail, the control board can be forced into electric heat mode. **This is a temporary solution until the heat pump system can be repaired.**

1. Locate the circuit board in the control section of the unit.
2. Locate the terminals where the outdoor sensor connects to the circuit board.
3. Using a small needle nose type pliers, disconnect one side of the

sensor from the circuit board. A 2-stage thermostat will provide Emergency heat.

4. This will appear to the circuit board as an outdoor coil freeze condition there-by energizing the electric resistance heater on the call for heat.
5. See "Manual Reset Limit Switch" (Figure 10, page 19) for resetting the limit switch if needed.

Troubleshooting sensors

⚠ DANGER

Electrical shock hazard — Disconnect power to the RetroAire replacement PTAC/PTHP before servicing or accessing the control compartment. Failure to do so could result in severe personal injury or death.

1. See for the location of sensor connections to the control board.
2. If temperature response of the indoor or outdoor sensor is not correct, disconnect the sensor from the control board and check the sensor resistance . Replace the sensor if its resistance is not close to the values in the table.

Table 1 Sensor resistance values

	Resistance, Kohms
77 (25°C)	10.0 K
50 (10°C)	19.9 K
35 (1.6°C)	30.0 K
30 (-1.1°C)	34.4 K

Figure 11 Sensor connections on control board

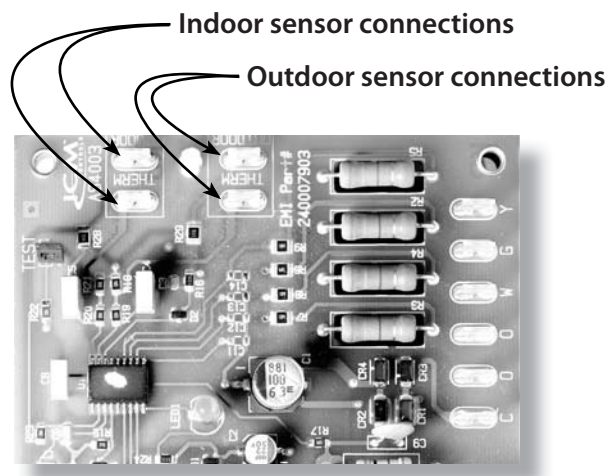

Maintenance & Troubleshooting *(continued)*

Troubleshooting

WARNING

The troubleshooting procedures below should only be conducted by a qualified technician.

Symptom	Suggestion
No heat or cooling	<ul style="list-style-type: none"> Check to see if the unit has power and if the thermostat is satisfied. If the thermostat is not satisfied, call your installing contractor or service contractor.
The thermostat calls for cooling, but cool air is not coming out of the unit.	<ul style="list-style-type: none"> Check for continuity between the thermostat and the unit. Also make sure 24 Vac is present across terminals C and R. Check outdoor coil for dirt debris, remove any foreign material. Locate the high pressure switch reset button and push button. Some units are equipped with an LCDI (Leakage Current Detection Interrupt) line cord. Make sure this line cord is reset by pressing the reset button at the line cord plug. Note: If the evaporator fan is operational and all of the above suggested procedures have been followed, and there is still no cooling being supplied by the unit, then contact a trained heating and cooling professional.
A light on the circuit board is blinking.	<ul style="list-style-type: none"> The circuit board uses this light for diagnostic purposes. The blinking codes are as follows: <ul style="list-style-type: none"> 1 blink = normal operation 2 blinks = compressor lockout (ASCT — Anti-Short Cycle Timer) 3 blinks = outdoor freeze condition 4 blinks = indoor freeze condition 5 blinks = simultaneous Y and W call (Straight cooling units only)
The circuit board light is blinking 3 or 4 times, but there is no freeze condition. (see table 1 p.31)	<ul style="list-style-type: none"> Make sure the sensors have not been damaged. Remove sensor wires from the control board and make resistance measurements, then compare them to the following sensor resistances. Indoor and outdoor coil sensor wires are labelled, as is the control board. Make sure the sensors are correctly wired? <ul style="list-style-type: none"> 77°F = 10KOhms 50F = 19.9KOhms 35F = 30KOhms 30F = 34.4KOhms
The thermostat is satisfied, but the fan is still running.	<ul style="list-style-type: none"> If the thermostat is set to auto mode, once the thermostat is satisfied, the fan will stay energized for an extra 60 seconds to purge the unit of excess cool or warm air in the plenum. If the thermostat fan switch is set to ON, the fan will stay energized regardless of whether the thermostat is satisfied or not. The only way to turn the fan off would be to turn the unit off or to turn the thermostat fan switch to AUTO.
The thermostat calls for heat, but no heat comes out of the unit.	<ul style="list-style-type: none"> Units equipped with electric heaters have a temperature limit switch to prevent the electric heater from reaching unsafe temperatures. If after calling for heating the heater is not energized, check for continuity across the limit. If the limit is open, replace it with an equivalent limit switch. Auto reset / Manual reset Switch (Requires trained professional)
The thermostat calls for heat while in heat pump mode, but heated air is not coming out of the unit.	<ul style="list-style-type: none"> Check to see if the unit has power or if the thermostat has been satisfied. If the unit has power and the thermostat is satisfied, turn the thermostat a few degrees above room temperature. Make sure the LCDI line cord has not tripped. (See Page 7 for information.) While in heat pump mode, make sure the thermostat is not energizing the O terminal. RetroAire units are designed to work in heat pump mode when 24vac is present across Y and C. Also, make sure the heat pump jumper on the control board is jumping the two pins labeled "HP" (see control board jumper locations, Figure 6, page 14 and discussion). Make sure there are no freeze conditions. Refer to blinking codes question above for more information.

Performance Data

Table 2 R30 C/H performance data

Model R30	Cooling	Sensible Heat Ratio	EER	Heat Pump	COP	Indoor Air Flow	Shipping Weight
	Btuh (kW)			Btuh (kW)		CFM (L/s)	lbs (Kg)
R 30 C 09	9,000 (2.6)	0.70	9.5	N/A	N/A	375 (177)	140 (64)
R 30 H 09	9,000 (2.6)	0.70	9.5	8,400 (2.5)	2.7	375 (177)	
R 30 C 12	11,200 (3.3)	0.68	8.4	N/A	N/A	400 (189)	
R 30 H 12	11,200 (3.3)	0.68	8.4	11,700 (3.2)	2.6	400 (189)	
R 30 C 15	14,000 (4.1)	0.63	8.0	N/A	N/A	400 (189)	
R 30 H 15	14,000 (4.1)	0.63	8.0	13,700	2.51	400 (189)	

Electrical Specifications

IMPORTANT

Due to ongoing product development, designs, specifications, and performance are subject to change without notice. Please consult the factory for further information.

Table 3 R30 C/H - 9,000 BTU electrical specifications

Power Supply Volt — 1-60		Compressor		Indoor Fan Motor		Outdoor Fan Motor		Electric Heat				Unit Electrical Ratings				
Volt	Min	RLA	LRA	FLA	Hp	FLA	Hp	Htr #	Volt	W	HA	TCA	THA	MCA	MOCP	Plug
115V	104	7.5	47	1.4	0.09	1.6	0.125	N/A	N/A	N/A	N/A	10.5	N/A	12.4	15	5-15P
208/ 230V	197	3.9	20	0.6	0.08	0.71	0.09	0	N/A	N/A	N/A	5.2	N/A	6.2	15	6-15P
								2	208	1636	7.9		8.5	10.6	15	6-15P
									230	2000	8.7		9.3	11.6		
								3	208	2454	11.8		12.4	15.5	20	6-20P
									230	3000	13		13.6	17.1		
								4	208	3271	15.7		16.3	20.4	25	6-30P
									230	4000	17.4		18	22.5		
								5	208	4089	19.7		20.3	25.3	30	6-30P
									230	5000	21.7		22.3	27.9		
								265V	240	3.32	18.8		0.67	0.08	0.71	0.09
2	265	2655	10	10.7	13.4	15	7-20P									
3	265	3983	15	15.7	19.6	20										
4	265	5310	20	20.7	25.9	30	7-30P									
5	N/A	N/A	N/A	N/A	N/A	N/A	N/A									

Table 4 R30 C/H - 12,000 BTU electrical specifications

Power Supply Volt — 1-60		Compressor		Indoor Fan Motor		Outdoor Fan Motor		Electric Heat				Unit Electrical Ratings				
Volt	Min	RLA	LRA	FLA	Hp	FLA	Hp	Htr #	Volt	W	HA	TCA	THA	MCA	MOCP	Plug
115V	104	12.7	63	1.4	0.09	0.1	1.25	0	N/A	N/A	N/A	15.4	N/A	18.5	30	5-20P
208/ 230V	197	5.6	29	0.6	0.08	0.71	0.09	0	N/A	N/A	N/A	6.9	N/A	8.3	15	6-15P
								2	208	1636	7.9		8.5	10.6	15	6-15P
									230	2000	8.7		9.3	11.6		
								3	208	2454	11.8		12.4	15.5	20	6-20P
									230	3000	13		13.6	17.1		
								4	208	3271	15.7		16.3	20.4	25	6-30P
									230	4000	17.4		18	22.5		
								5	208	4089	19.7		20.3	25.3	30	6-30P
									230	5000	21.7		22.3	27.9		
								265V	240	4.6	20		0.67	0.08	0.71	.09
2	265	2655	10	10.7	13.4											
3	265	3983	15	15.7	19.6	20										
4	265	5310	20	20.7	25.9	30	7-30P									
5	N/A	N/A	N/A	N/A	N/A	N/A	N/A									

Electrical Specifications

IMPORTANT

















Due to ongoing product development, designs, specifications, and performance are subject to change without notice. Please consult the factory for further information.

Table 5 R30C - 15,000 BTU electrical specifications

Power Supply Volt — 1-60		Compressor		Indoor Fan Motor		Outdoor Fan Motor		Electric Heat				Unit Electrical Ratings					
Volt	Min	RLA	LRA	FLA	Hp	FLA	Hp	Htr #	Volt	W	HA	TCA	THA	MCA	MOCP	Plug	
208/ 230V	197	7.4	33	0.6	0.08	0.71	0.09	0	N/A	N/A	N/A	8.7	N/A	10.6	15	6-15P	
								2	208	1636	7.9		8.5	10.6	15	6-15P	
									230	2000	8.7		9.3	11.6			
								3	208	2454	11.8		12.4	15.5	20	6-20P	
									230	3000	13		13.6	17.1			
								4	208	3271	15.7		16.3	20.4	25	6-30P	
									230	4000	17.4		18	22.5			
								5	208	4089	19.7		20.3	25.3	30	6-30P	
									230	5000	21.7		22.3	27.9			
								265V	240	6	28		0.67	0.08	0.71	0.09	0
2	265	2655	10	10.7	13.4												
3	265	3983	15	15.7	19.6	20	30					7-30P					
4	265	5310	20	20.7	25.9												
5	N/A	N/A	N/A	N/A	N/A	N/A											N/A

Table 6 R30H - 15,000 BTU electrical specifications

Power Supply Volt — 1-60		Compressor		Indoor Fan Motor		Outdoor Fan Motor		Electric Heat				Unit Electrical Ratings					
Volt	Min	RLA	LRA	FLA	Hp	FLA	Hp	Htr #	Volt	W	HA	TCA	THA	MCA	MOCP	Plug	
208/ 230V	197	6.6	33	0.6	0.08	1.0	0.25	0	N/A	N/A	N/A	8.2	N/A	9.9	15	6-15P	
								2	208	1636	7.9		8.5	10.6	15	6-15P	
									230	2000	8.7		9.3	11.6			
								3	208	2454	11.8		12.4	15.5	20	6-20P	
									230	3000	13		13.6	17.1			
								4	208	3271	15.7		16.3	20.4	25	6-30P	
									230	4000	17.4		18	22.5			
								5	208	4089	19.7		20.3	25.3	30	6-30P	
									230	5000	21.7		22.3	27.9			
								265V	240	5.6	28		0.67	0.08	1.3	0.25	0
2	265	2655	10	10.7	13.4												
3	265	3983	15	15.7	19.6	20	30					7-30P					
4	265	5310	20	20.7	25.9												
5	N/A	N/A	N/A	N/A	N/A	N/A											N/A

VOLTAGE	125V		250V			265V		
	15(A)	20(A)	15(A)	20(A)	30(A)	15(A)	20(A)	30(A)
PLUG	 5-15 P	 5-20 P	 6-15 P	 6-20 P	 6-30 P	 7-15 P	 7-20 P	 7-30 P
RECEPTACLE	 5-15 R	 5-20 R	 6-15 R	 6-20 R	 6-30 R	 7-15 R	 7-20 R	 7-30 R

ECR International Inc
2201 Dwyer Avenue
Utica, NY 13501
e-mail: info@RetroAire.com



An ISO 9001-2008 Certified Company