

# RETROAIRE™

*The Right Fit for Comfort*

## R45C/H

Packaged Terminal Air Conditioner (PTAC)  
Packaged Terminal Heat Pump (PTHP)

### Straight cooling nominal capacities

9,000	12,000	15,000	18,000	Btuh
2.6	3.5	4.4	5.3	kW

### Heat pump nominal capacities

9,000	12,000	15,000	Btuh
2.6	3.5	4.4	kW

## Specifications and Performance

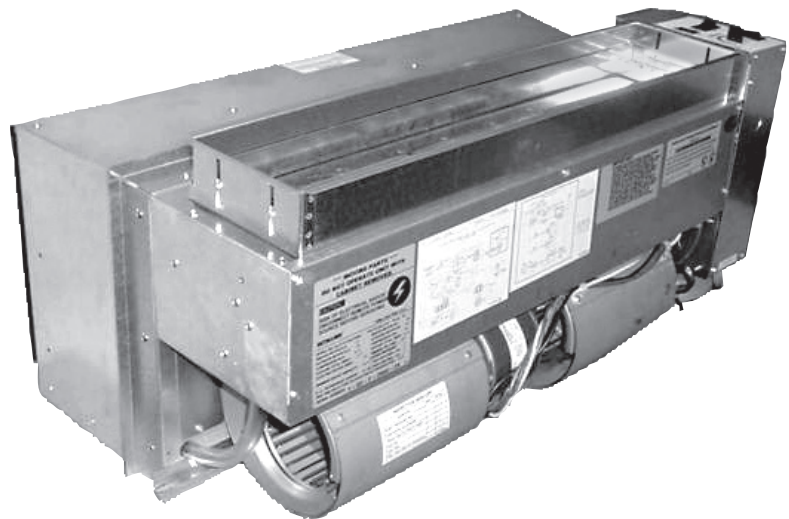

ECR International Inc  
2201 Dwyer Avenue  
Utica, NY 13501  
e-mail: [info@RetroAire.com](mailto:info@RetroAire.com)

## R45C | R45H

Replacement for:  
American Standard Type 40



An ISO 9001-2008 Certified Company

## Contents

### Contents

<b>Contents</b>	<b>2</b>
<b>General Product Information</b>	<b>3-5</b>
Product description . . . . .	2
Standard controls and components. . . . .	2
Factory-installed options ( <i>consult the factory</i> ) . . . . .	3
Field-installed accessories . . . . .	3
R10C/R10H Chassis . . . . .	4-5
<b>PTAC/PTHP Model Coding</b>	<b>6</b>
Field Installed Accessories . . . . .	6
<b>Features</b>	<b>7-8</b>
Optional wall-mounted thermostats . . . . .	8
<b>Sequence of Operation</b>	<b>9-10</b>
Initial Power-Up or power restoration . . . . .	9
R__C / R__H: Cooling Operation . . . . .	9-10
R__C / R__H: Heating Operation . . . . .	10
R__H: Mechanical Heating "Heat Pump". . . . .	10
R__H: Auxiliary Heating "Electric" or "Hydronic" . . . . .	10
<b>Performance Data</b>	<b>11</b>
<b>Electrical Specifications</b>	<b>12-14</b>

### NOTICE

The RetroAire™ replacement PTAC/PTHP is backed by EMI and ECR International and is tested and rated in accordance with:

ARI Standards 310/380

UL-484

Due to ongoing product development, product designs and specifications may change without notice.

Please contact the factory for more information.

## General Product Information

### Product description

RetroAire Replacement Packaged Terminal Air Condition/Heat Pumps units are available in straight cooling (PTAC) or as heat pump systems (PTHP). Both the PTAC and PTHP configurations fit the wall sleeves of the units listed on the front cover. Heat pumps (PHTP) reduce energy costs and will operate in mechanical heat mode down to an outdoor temperature of 40°F (4.4°C), Below 40°F (4.4°C) heating is accomplished by an auxiliary heat option.

The Retroaire PTAC/PHTP units:

- Use R-410A refrigerant. This refrigerant is not affected by a phase out schedule.
- Include high-efficiency rotary compressors, protected by a 5-year warranty.
- Include an enhanced, high-efficiency heat exchangers.
- Offer two fan speeds.
- Incorporate positive condensate re-evaporation to improve efficiency.
- Have an optional motorized fresh-air feature with a positive pressure seal.

RetroAire PTAC/PHTP ratings meet or exceed ASHRAE 90.1 Standards for energy efficiency:

- PTAC/PHTP units are available in nominal sizes of 9,000 Btuh, (2.6kW) 12,000 Btuh (3.5kW) or 15,000 Btuh (4.4kW).
- PTAC units (straight cooling only) are also available at 18,000 Btuh (5.3kW).
- Energy Efficiency Rating (EER) as high as 10.
- Coefficient of performance (COP) ratings as high as 2.90 for heat pumps.

### Standard controls and components

#### Construction

- 20-gauge galvanized steel construction of chassis.
- Condenser baffle options to accommodate extended wall sleeve applications. (Consult the factory for special order items).
- Powder-coated condenser and evaporator drain pan.
- Foam strip seal for supply air duct.
- Weather strip insulation.

#### Air systems

- Motors are thermally-protected PSC type.
- Air-stream surfaces are insulated with 1/4" fiber-glass or 1/8" (3.2 mm) Volara™.
- The indoor fan is a forward-curved type, directly mounted to the motor shaft.
- Unit mount controls include a field selection switch to control indoor fan by either cycling with compressor operation or continuously with the unit.

#### Condensate removal

- The outdoor fan incorporates condensate slinger ring — Condensate is thrown onto the coil, where it evaporates, improving system performance.
- Thermostatic drain pan valve for condensate elimination when outdoor temperature drops below 60°F (15°C) (heat pump units only).

#### Controls

- Unit-mounted operating controls include thermostat, fan speed control, heat/cool switch, fan cycle switch, fresh air switch (if equipped)
- Ability to utilize 1-stage or 2-stage thermostat. 2 stage thermostat is capable of activating emergency heat if an auxiliary heat source is available.
- Low ambient protection — see "Microprocessor control board" for details.
- Ability to control a normally-open or normally-closed motor valve switch (on hydronic heat units only). Valve controls must be ordered for 24V or line voltage.
- All hydronic heat units include molex plugs for connection of hydronic valve motor.
- Remote mount controls include fan speed control and fresh air switch (if equipped)
- All units are equipped with manual reset high pressure switch which prevents abnormal high pressure operation, increasing compressor reliability.

#### Microprocessor control board

- The universal control board is used in straight cooling, electric resistance heat, hydronic heat, or cooling/heat pump applications.
- Random start timer prevents multiple units from simultaneous startups after power interruption or on initial power-up.
- Fan purge — fan remains on for 60 seconds after heat/cool is satisfied.
- Anti-short-cycle compressor protection prevents the compressor from rapid cycling, increases compressor reliability.
- Freeze-protection prevents evaporator coil freeze up, improving compressor reliability.
- Low ambient lockout prevents compressor operation in outdoor temperatures less than 40°F (4.4°C). (On PTHP units supplied with unit-mounted control, the control causes automatic changeover to auxiliary heat, if installed.)
- Test operation — all timers are temporarily suppressed to allow ease of testing or troubleshooting.
- Control board LED provides self-diagnostic troubleshooting codes, see "Sequence of operation."

### Factory-installed options *(consult the factory)*

- 265/277V (12 and 15 only)
- 115V (09 & 12 Models Only)
- Corrosion-resistant coil option — used for seacoast and harsh-environment usage; coated aluminum fin/copper tube condenser coil.
- Motorized fresh-air damper
- Supplemental electric heat — see heat options on "Model coding" on page 6.
- Hydronic heat controls
- Front air intake

### Field-installed accessories

- Hydronic heat — the coil assembly is shipped loose for field installation.
- Remote wall thermostat — digital 1-stage or 2-stage available.
- Wall sleeves, louvers, and cabinets (contact factory)
- Aquastat - delays fan start-up until coil reaches 100°F (38°C) to virtually eliminate "cold" blow condition.
- Hydronic control valve, Water 2 way & 3 way
- Hydronic control valve, Steam 2 way
- Hydronic Isolation valve, 1/2 in Sweat Connection.

## General Product Information *(continued)*

**Figure 1** R45C | R45H chassis

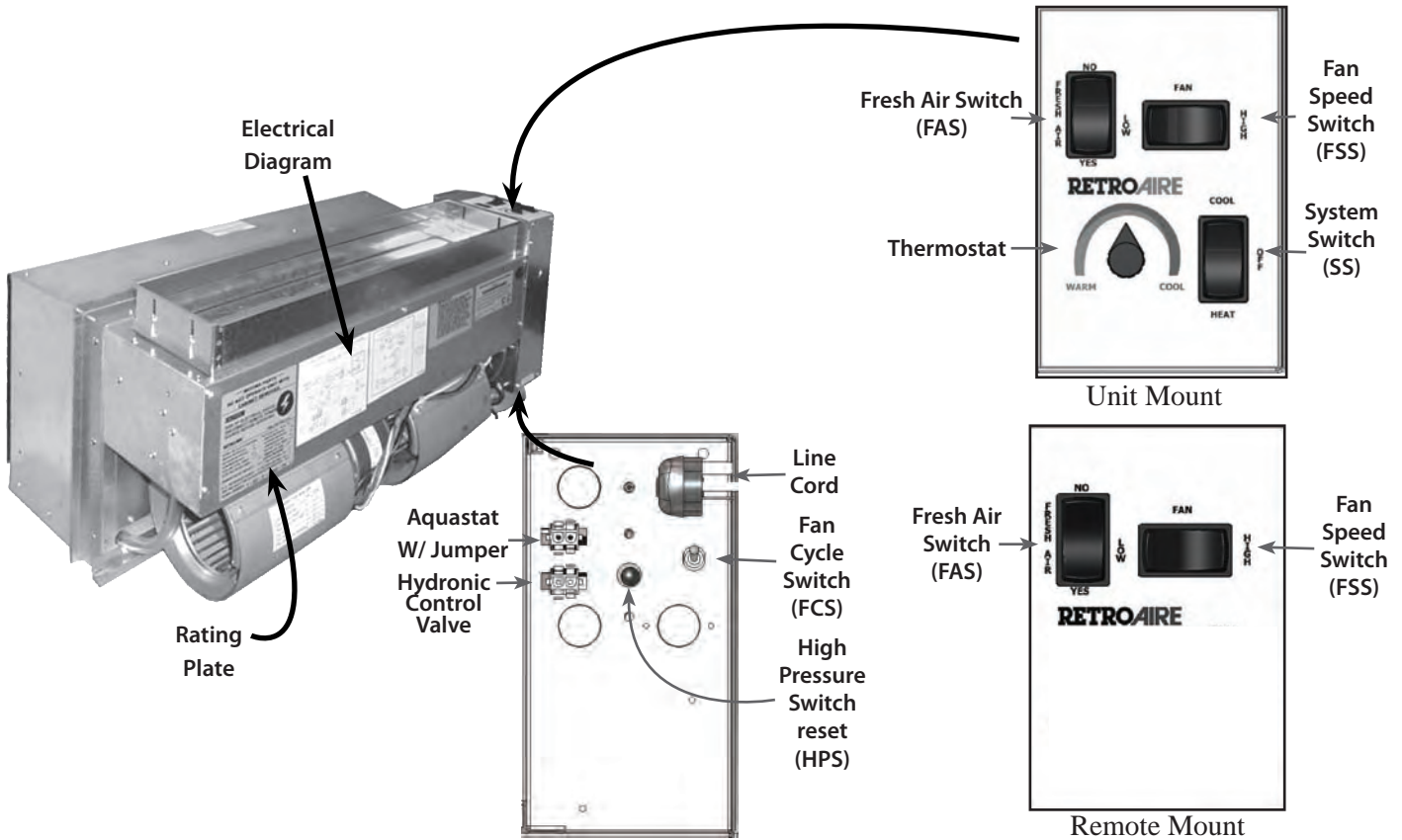

**Figure 2** R45C | R45H chassis

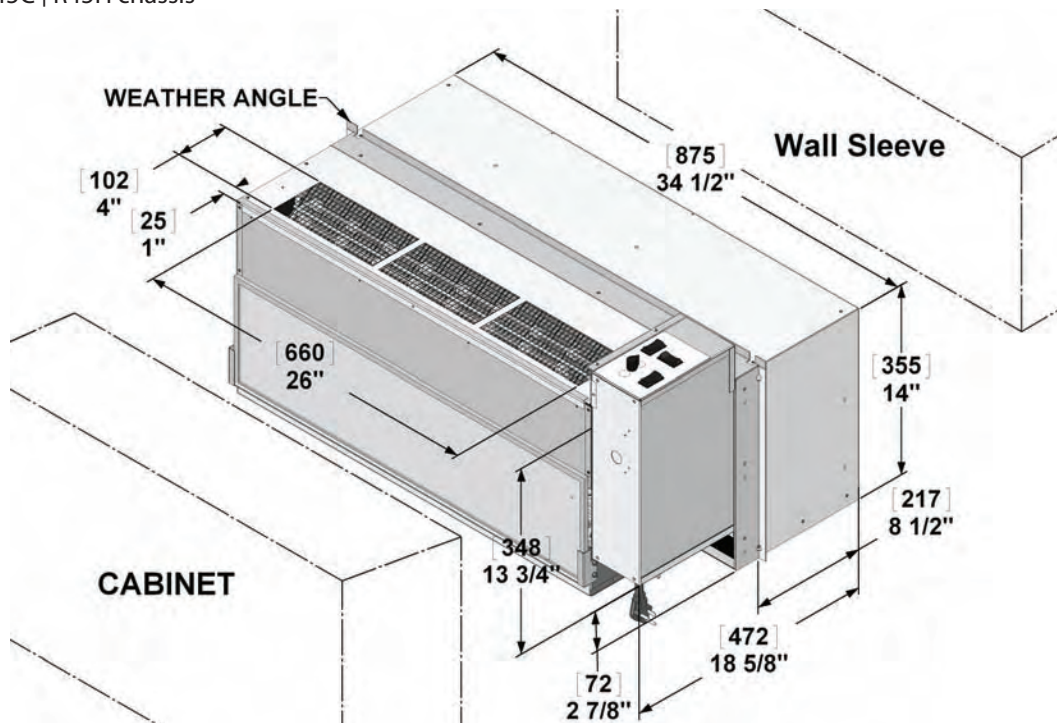

Dimensions in [ ] are in mm



## General Product Information *(continued)*

**Figure 3** R45C | R45H Weather Angles

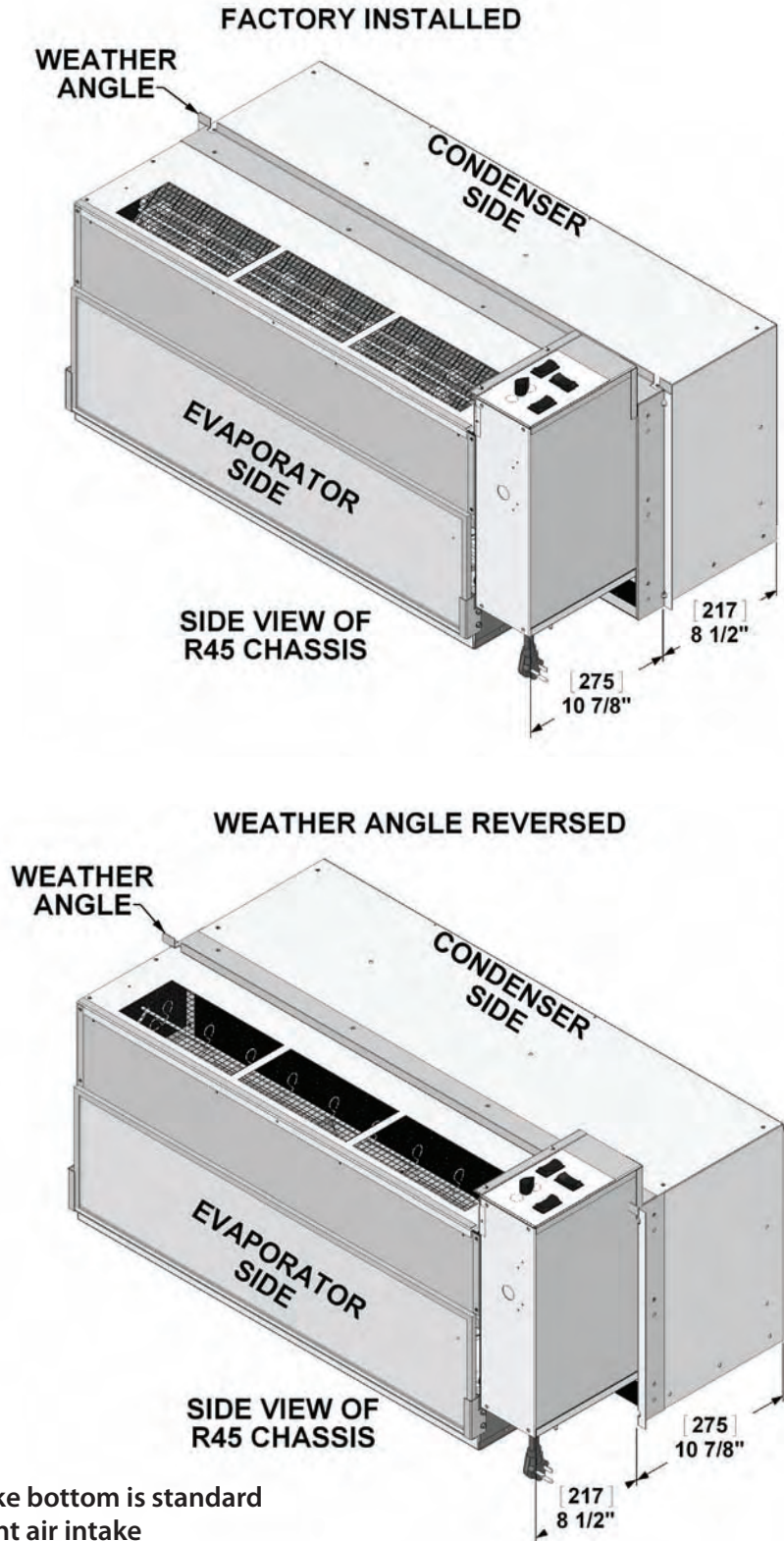

**Note:**

- Evaporator air intake bottom is standard
- Optional Kit for front air intake

## PTAC/PTHP Model Nomenclature

**Figure 4** Model coding

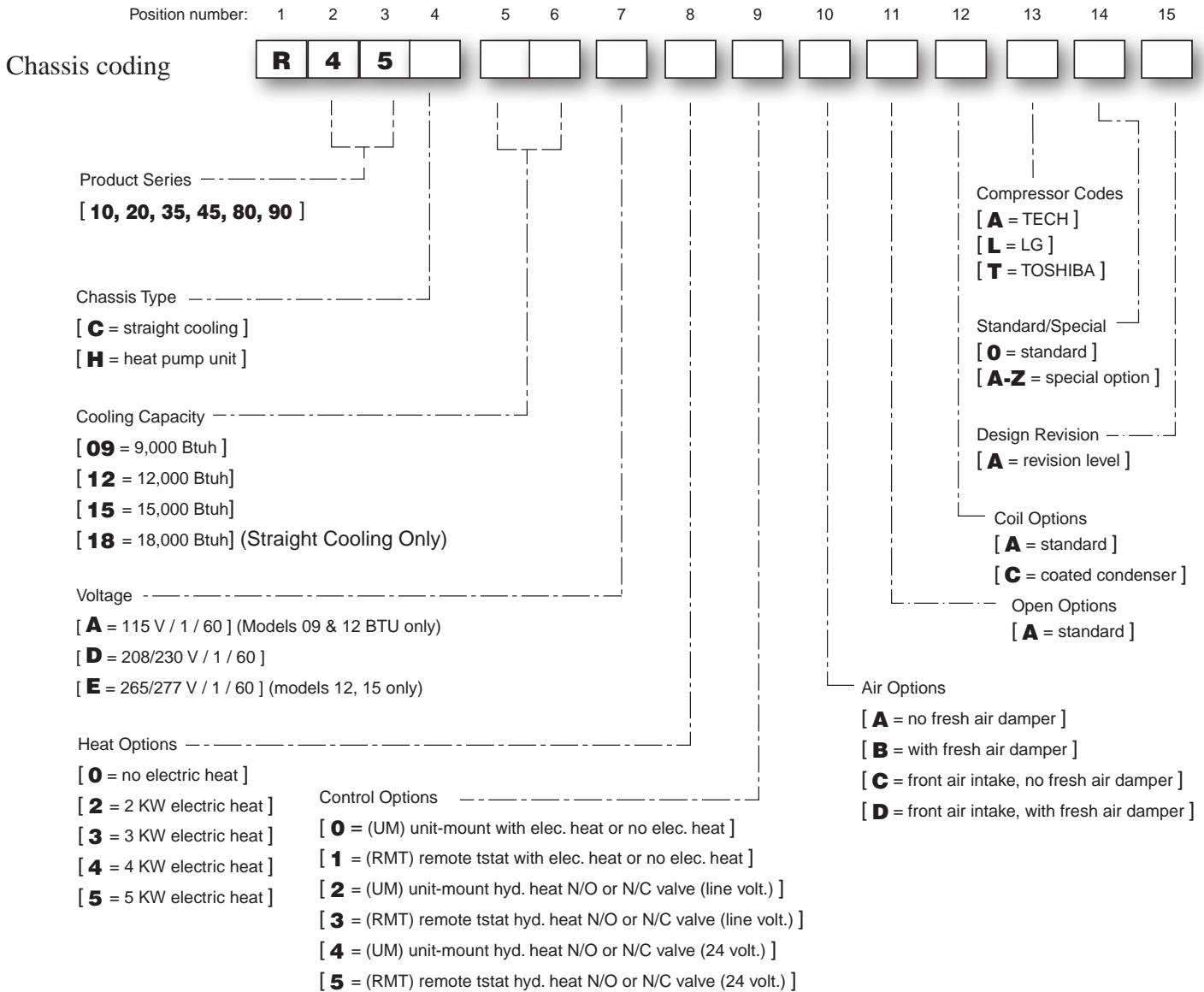

### Field Installed Accessories [items to be selected during the ordering process]

<input type="checkbox"/>	Remote thermostat	<input type="checkbox"/>	Aquastat
<input type="checkbox"/>	Hydronic Heat Coil(contact factory)	<input type="checkbox"/>	Hydronic Control Valve
<input type="checkbox"/>	Single Piece cabinet / wall sleeve(contact factory)	<input type="checkbox"/>	Hydronic Isolation Valve

## Features

### Indoor coil freeze protection *(standard)*

This feature will prevent the indoor coil from freeze up in the cooling mode.

- Indoor coil freeze up can occur due to a dirty air filter, restricted or poor air flow, low refrigerant charge or low room or outdoor temperatures.
- This in turn can cause compressor damage.
- Should a freeze condition be detected, the compressor and outdoor fan will be switched off for a minimum of three minutes until the freeze condition is satisfied.
- During this time the indoor fan will continue to run to aid in the defrost process.

### Condensate removal *(standard)*

The RetroAire replacement unit (cooling operation) is designed to eliminate condensate by slinging it onto the outdoor coil.

- Condensate drains through the bulkhead to the area near the outdoor fan.
- As part of its normal operation, the unit will produce condensate and collect it in the base pan of the unit. There it is picked up by the outdoor fan slinger ring and deposited onto the condenser coil. During the cooling season, this improves the unit's efficiency by maintaining reduced refrigeration system pressures.
- Base pan has overflow notches, if too much condensate is produced notches allow condensate to flow out of the basepan and into the wallsleeve out of the building.

### Thermostatic drain pan valve *(standard on heat pump units)*

On heat pump models (PTHP), condensate can accumulate in the outdoor drain pan during the heat pump cycle.

- PTHP units include a thermostatic drain valve that opens when outdoor temperatures fall below 60°F (15°C).
- When the drain valve opens, condensate flows from the drain pan onto the bottom of the wall sleeve, where it drains to the outside.
- This keeps the base pan free of condensate water, which could otherwise freeze during colder outdoor temperatures.

### Random start feature *(standard)*

The random start feature is initiated on initial power-up or after a power interruption.

- The controller adds a random time delay (from 5–120 seconds) on start-up, preventing the compressor from starting.
- This staggers the starting of multiple units in a single facility, preventing a large surge that might occur if all units started at the same time.

### Anti-short cycle timer *(standard)*

The microprocessor control uses this timing to prevent short-cycling of the compressor.

- When the compressor cycles off on a heating or cooling call, the controller starts a 180-second timer.
- The compressor will not be allowed to start until this time has elapsed.
- On initial power-up or after a power failure, this timing occurs after the random start timing.

### Power cord with integral safety protection

*(standard)*

All PTAC/PTHP units rated 250v or less are equipped with a power cord with integral safety protection as standard.

- Providing personal shock protection as well as arcing and fire prevention, the device is designed to sense any damage in the line cord and disconnect power before a fire can occur.
- Tested in accordance with Underwriters Laboratories, the cord set also offers a unique “passive” operation, meaning the unit does not require resetting if main power is interrupted.

### Heat pump

Heat pump units are “Limited Range” and should be equipped with back-up electric resistance or hydronic heat. Limited Range heat pumps are designed to operate when outdoor temperatures are between 75°F(24°C) and 40°F(4.4°C) and with a maximum indoor temperature of 80°F(26.6°C). The unit is equipped with a reversing valve that is energized for cooling and de-energized in heating mode. Electric heating or hydronic heat will operate using the onboard control logic below the operating conditions of the heat pump.

### Hydronic heating *(optional)*

An optional hydronic heat package may be selected in lieu of electric heat. Heating operation is essentially the same as that of units with electric heat.

### Aquastat connection *(optional)*

All replacement PTAC/PTHP's with hydronic heat are supplied with a standard line volt Aquastat connection. The field installed Aquastat delays the fan operation until the hydronic coil reaches a temperature of 100°F (38°C).

## Features *(continued)*

### Motorized fresh air damper *(optional)*

The optional motorized fresh air damper allows fresh air into the space to be conditioned. When the Fresh Air switch is in the "YES" position the damper door is open and allows fresh air into the space. This feature is only available when the indoor fan is on. When the damper door switch is in the "NO" position, the damper door is closed and does not allow air in the space.

### Optional wall-mounted thermostats

#### Thermostats available from EMI

EMI offers a thermostat that is compatible with your PTAC/PTHP unit.

- Select EMI part number 240008208 from the latest RetroAire price list for this option. This is a single stage, cool/heat, thermostat that can be used in all RetroAire cooling, heating or heat pump applications.
- The thermostat has an adjustable setpoint range of between 45°F(7°C) and 90°F(32°C).
- For heat pumps another option is EMI part number 240008209. This is a 2 stage heat/cool thermostat which allows for emergency heat.

### • Selecting a thermostat *(by others)*

When selecting a thermostat other than one offered by EMI, choose a single stage heat/cool, 24v thermostat.

### Straight cooling with electric heat or hydronic heat (**R10C** — **PTAC's**)

Select a thermostat that is compatible with a cooling/electric heat system.

The thermostat should have "R", "Y", "W", "C" and "G" terminals.

### Heat pump with electric heat (**R\_H-PTHPs**)

Select a thermostat that is compatible with a cooling/single-stage heat/heat pump system.

The thermostat should have "R", "Y", "O" and "G" terminals. RetroAire units are single stage heating only.

The electric heat and heat pump will not operate simultaneously.



## Sequence of Operation

The following Sequence of Operation applies to PTAC/PTHP units.

The **R\_\_C** units are straight cool, single stage air conditioners available with electric or hydronic heat.

The **R\_\_H** units are limited range, single stage heat pump. Mechanical compression heating (heat pump mode) is locked out at outdoor temperatures of approximately 35 °F (1.7 °C) and below. Below these ambient temperatures, the auxiliary electric or hydronic heat will be used.

### General

The unit is controlled by a microprocessor. Thermostat and control connections are made to the control board.

**Figure 5** - Control Board

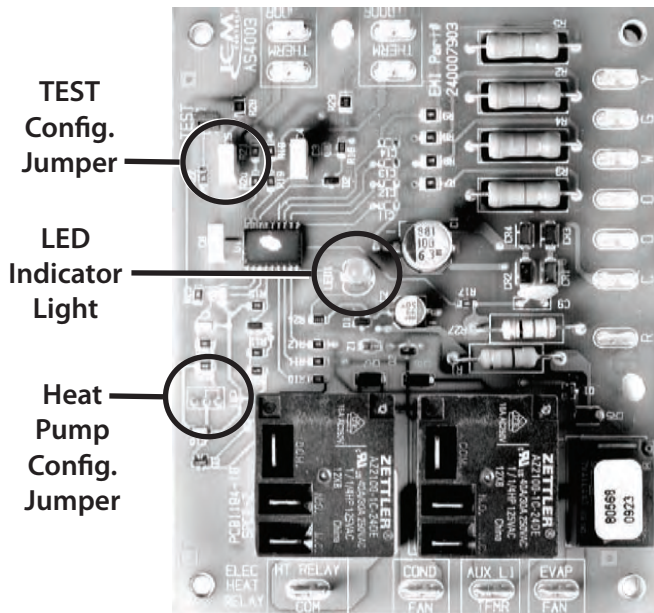

**Two configuration jumpers are located on the board, see Figure 8. The Heat Pump Configuration Jumper is a 3 pin jumper.**

- Straight **Cool** units **R\_\_C**, the jumper should be located on the outside two pins.
- **Heat** Pump units **R\_\_H**, the jumper should be located on the inside two pins.

A second configuration jumper “TEST” allows for the control’s internal timers to be by-passed for test purposes. Placing the jumper on the two pins enables the test mode.

A status LED (Light Emitting Diode), LED1 is located on the center of the board. A series of blinks communicates the status of the board. Between the blink sequence is a separation of approximately 2 seconds. The Status Code is listed below.

Trouble Code (Blinks)	Status
1	Normal Operation
2	Anti-Short Cycle Timer Active
3	Outdoor Coil Freeze Protection
4	Indoor Coil Freeze Protection
5	Simultaneous “Y” and “W” Call

### Initial Power-Up or Power Restoration

When power is applied to the unit, either for the first time or after a power failure, the board will initialize itself. During the initialization, LED1 will be lit continuously for approximately 5 seconds. Following the initialization, a random start timer is initiated. This timer adds a randomly selected 5-120 seconds to the start-up sequence, reducing the possibility of multiple units starting at the same time. Once the random start timer has expired, a 180 second Anti-Short Cycle Timer is initiated and the Processor Board Trouble Code LED is set to blink a 2 flash code. This timer prevents the compressor from rapid cycling. After the Anti-Short Cycle Timer expires, the Processor Board Trouble Code LED is set to blink a 1 blink Trouble Code, indicating normal operation.

### R\_\_C / R\_\_H; Cooling Operation

Unit mount controls

With the System Switch [SS] set to “Cool”, and the Fan Cycle Switch [FCS] set to “On” (Continuous Fan Operation), the indoor fan motor will start. If the Fan Cycle Switch [FCS] is set to “Off” (Cycling Fan Operation), the indoor fan motor will start with a call for cooling from the internal thermostat [T’stat]. If the unit is equipped with a Motorized Fresh Air Damper, and is active with the Fresh Air Switch [FAS], the damper will open with a call for the indoor fan. If the room temperature is below the thermostat setting the fan operation will continue as noted above. If the room temperature is above the thermostat setting, the reversing valve will be energized, the compressor and outdoor fan will start provided the Anti-Short Cycle Timer has timed out from the initial power-up, power restoration or a previous compressor on cycle. Operation will continue until the room temperature satisfies the thermostat. Once the room temperature falls below the set point by 3 °F (2 °C), the compressor, outdoor fan motor and reversing valve will de-energize. If the FCS is set to “Off”, the indoor fan will continue to operate for 60 seconds after the compressor stops. If the FCS is set to “On”, the indoor fan will continue to operate. As soon as the compressor is de-energized, the Anti-Short Cycle Timer will be initialized and will prevent the compressor from starting again for another 180 seconds. While the Anti-Short Cycle Timer is active, the Processor Board Trouble Code

## Sequence of Operation

LED is set to blink a 2 flash code. After the Anti-Short Cycle Timer expires, the Processor Board Trouble Code LED is set to blink a 1 blink Trouble Code, indicating normal operation.

### NOTE:

- Remote-Mount Cooling Operation depends on the features of the wall-mounted thermostat. By default the fan will cycle with a call for cooling. For thermostats with an **AUTO / ON** fan switch, the fan will run continuously if this is “ON” (Continuous Fan Operation). The fan will cycle with a call for cooling if this is set to “AUTO” (Cycling Fan Operation).
- In cooling the units will not start if the indoor air temperature is 60°F (15.5 °C) or below or if the outdoor temperature is below 40°F (4.5°C).

### R\_\_C / R\_\_H; Heating Operation

With the System Switch [SS] set to “Heat”, and the Fan Cycle Switch [FCS] set to “On” (Continuous Fan Operation), the indoor fan motor will start. If the Fan Cycle Switch [FCS] is set to “Off” (Cycling Fan Operation), the indoor fan motor will start with a call for heating from the internal thermostat [T’stat]. If the unit is equipped with a Motorized Fresh Air Damper, and is active with the Fresh Air Switch [FAS], the damper will open with a call for the indoor fan. If the room temperature is above the thermostat setting the fan operation will continue as noted above. If the room temperature is below the thermostat setting, the action of the unit will depend on the outdoor temperature and the freeze sensor status.

**NOTE:** Remote-Mount Heating Operation depends on the features of the wall-mounted thermostat. By default the fan will cycle with a call for Heating. For thermostats with an **AUTO / ON** fan switch, the fan will run continuously if this is “ON” (Continuous Fan Operation). The fan will cycle with a call for heating if this is set to “AUTO” (Cycling Fan Operation).

#### • R\_\_H; Mechanical Heating “Heat Pump”

”If the outdoor coil temperature remains above 25 °F (-4 °C), the compressor and outdoor fan will start provided the Anti-Short Cycle Timer has timed out from the initial power-up, power restoration or a previous compressor on cycle. Operation will continue until the room temperature satisfies the thermostat. Once the room temperature rises above the set point by 3 °F (2 °C), the compressor and outdoor fan motor will de-energize. If the FCS is set to “Off”, the indoor fan will continue to operate for 60 seconds after the compressor stops. If the FCS is set to “On”, the indoor fan will continue to operate. As soon as the compressor is de-energized, the Anti-Short Cycle Timer will be initialized and will prevent the compressor from starting again for another 180 seconds. While the Anti-Short Cycle Timer is active, the Processor Board Trouble Code LED is set to blink a 2 flash code. After the Anti-Short Cycle Timer expires, the Processor Board Trouble Code LED is set to flash a 1 blink Trouble Code, indicating normal operation.

#### • R\_\_H; Auxiliary Heating “Electric” or “Hydronic”

If the outdoor coil temperature falls to 25 °F (-4 °C) or below for 180 seconds at anytime during a heating call, the compressor and outdoor fan motor will be de-energized and auxiliary heat

will be energized. The Anti-Short Cycle Timer will be initiated, prohibiting compressor operation for 180 seconds. The Processor Board Trouble Code LED will flash a 3 blink Trouble Code, indicating auxiliary heat operation. Heating operation with auxiliary heat will continue until the outdoor coil sensor reaches 50 °F (10 °C).

#### • “Electric Heat”

With the System Switch [SS] set to “Heat”, and the Fan Cycle Switch [FCS] set to “On” (Continuous Fan Operation), the indoor fan motor will start. If the Fan Cycle Switch [FCS] is set to “Off” (Cycling Fan Operation), the indoor fan motor will start with a call for heating from the internal thermostat [T’stat]. If the unit is equipped with a Motorized Fresh Air Damper, and is activated with the Fresh Air Switch [FAS], the damper will open with a call for the indoor fan. If the room temperature is above the thermostat setting the fan operation will continue as noted above. If the room temperature is below the thermostat setting, the electric heater is energized until the room temperature satisfies the thermostat. Once the room temperature increases above the set point by 3 °F (2 °C), the electric heaters will de-energize.

#### • “Hydronic Heat”

If the FCS is set to “On” (Continuous Fan Operation) and the unit has an AquaStat, the indoor fan and fresh air motorized damper operation will be controlled by the Aquastat. If the AquaStat senses a temperature of 80 ± 5 °F (26 ± 3 °C) or below, the indoor fan will shut down and the motorized damper will close fresh air door. With a call for heat, a signal from the processor board will activate the water or steam valve. If the unit is equipped with a field installed AquaStat [AS], the indoor fan start will be delayed until the hydronic coil reaches 100 ± 5 °F (38 ± 3 °C). The signal to the water or steam valve will continue until the room temperature rises above the set point by 3 °F (2 °C). If the FCS is set to “Off”, the indoor fan will continue to operate for 60 seconds or until the hydronic coil temperature as sensed by the AquaStat reaches 80 ± 5 °F (26 ± 3 °C), whichever occurs first. If the FCS is set to “On”, the indoor fan will de-energize if the AquaStat senses a temperature of 80 ± 5 °F (26 ± 3 °C) or below.

#### • “Remote Wall Thermostat Controls”

Cooling and Heating operates identical to unit mount controls. See remote controls manual for control details. Remote units do not use a system switch, or FCS.

## Performance Data

**Table 1** R45 C/H performance data

Model R45	Cooling	Sensible Heat Ratio	EER	Heat Pump	COP	Indoor Air Flow	Fresh Air Inlet Flow	Outdoor Sound Level	Shipping Weight
	Btuh (kW)			Btuh (kW)		CFM (L/s)	CFM (L/s)	dBa	lbs (Kg)
R_C 09	9,500 (2.8)	0.79	10.0	N/A	N/A	400 (189)	35 (17)	75	140 (64)
R_H 09	9,500 (2.8)	0.79	10.0	8,500 (2.5)	2.90	400 (189)			
R_C 12	12,300 (3.6)	0.66	9.0	N/A	N/A	400 (189)	50 (24)	69	140 (64)
R_H 12	12,300 (3.6)	0.66	9.0	11,700 (3.4)	2.60	400 (189)			
R_C 15	14,700 (4.3)	0.69	8.3	N/A	N/A	425 (200)	60 (28)	70	140 (64)
R_H 15	14,700 (4.3)	0.69	8.3	14,000 (4.1)	2.52	425 (200)			
R_C 18	16,500 (4.8)	0.67	8.3	N/A	N/A	425 (200)	95 (45)	69	140 (64)

**Table 2** R45 C/H performance data

Model	Hydronic Coil Code Part Number	Air Entering Dry Bulb		Air Entering Wet Bulb		Air Entering Flow Rate		Water Flow		Water Entering		Capacity		Pressure Drop		Water Leaving		Water Delta	
		°F	°C	°F	°C	CFM	m³/min	GPM	LPM	°F	°C	Btu/h	kW	ft H2O	m H2O	°F	°C	°F	°C
R45	104 000 130	70	21	56	13	450	12.7	2.9	11.1	180	82	14,300	4.2	2.8	0.8	170	77	10	6
						400	11.3	2.8	10.4	180	82	13,500	4.0	2.5	0.8	170	77	10	6
						450	12.7	1.7	6.4	140	60	8,400	2.5	1.1	0.3	130	54	10	6
						400	11.3	1.6	6.1	140	60	7,900	2.3	1.0	0.3	130	54	10	6
						450	12.7	3.0	11.4	180	82	14,400	4.2	2.9	0.9	170	77	10	5
						400	11.3	3.0	11.4	180	82	13,600	4.0	2.9	0.9	171	77	9	5
						450	12.7	3.0	11.4	140	60	9,000	2.6	3.1	0.9	134	57	6	3
						400	11.3	3.0	11.4	140	60	8,600	2.5	3.1	0.9	134	57	6	3
						450	12.7	2.0	7.6	180	82	13,700	4.0	1.4	0.4	166	74	14	8
						400	11.3	2.0	7.6	180	82	13,000	3.8	1.4	0.4	167	75	13	7
						450	12.7	2.0	7.6	140	60	8,600	2.5	1.5	0.5	131	55	9	5
						400	11.3	2.0	7.6	140	60	8,200	2.4	1.5	0.5	132	55	8	5
						450	12.7	1.0	3.8	180	82	12,100	3.5	0.4	0.1	155	68	25	14
						400	11.3	1.0	3.8	180	82	11,500	3.4	0.4	0.1	156	69	24	13
						450	12.7	1.0	3.8	140	60	7,500	2.2	0.4	0.1	125	52	15	9
						400	11.3	1.0	3.8	140	60	7,200	2.1	0.4	0.1	125	52	15	8
R45	104 000 305	70	21	56	13	450	12.7	7.2	27.2	180	82	35,100	10.3	1.2	0.4	170	77	10	6
						400	11.3	6.7	25.3	180	82	32,600	9.5	1.1	0.3	170	77	10	6
						450	12.7	4.1	15.4	140	60	20,100	5.9	0.5	0.1	130	54	10	6
						400	11.3	3.8	14.4	140	60	18,700	5.5	0.4	0.1	130	54	10	6
						450	12.7	3.0	11.4	180	82	30,500	8.9	0.3	0.1	159	71	21	12
						400	11.3	3.0	11.4	180	82	28,800	8.4	0.3	0.1	160	71	20	11
						450	12.7	3.0	11.4	140	60	18,900	5.5	0.3	0.1	127	53	13	7
						400	11.3	3.0	11.4	140	60	17,900	5.2	0.3	0.1	128	53	12	7
						450	12.7	2.0	7.6	180	82	27,400	8.0	0.1	0.0	152	67	28	16
						400	11.3	2.0	7.6	180	82	26,900	7.9	0.1	0.0	153	67	27	15
						450	12.7	2.0	7.6	140	60	16,900	4.9	0.1	0.0	123	50	17	10
						400	11.3	2.0	7.6	140	60	16,200	4.7	0.1	0.0	124	51	16	9
						450	12.7	1.0	3.8	180	82	21,100	6.2	0.0	0.0	137	58	43	24
						400	11.3	1.0	3.8	180	82	20,400	6.0	0.0	0.0	138	59	42	23
						450	12.7	1.0	3.8	140	60	11,800	3.5	0.0	0.0	116	47	24	13
						400	11.3	1.0	3.8	140	60	11,400	3.3	0.0	0.0	117	47	23	13

### NOTICE

Due to Retroaire's ongoing development programs, design, specifications, and performance data is subject to change without notice. Please consult the factory for further information. For the most current unit/system performance data, please refer to our website, at [www.ecrinternational.com](http://www.ecrinternational.com).

Tested/Rated  
in Accordance with  
ARI 310/380 and  
UL Standard 484

## Electrical Specifications

### IMPORTANT

Due to ongoing product development, designs, specifications, and performance are subject to change without notice. Please consult the factory for further information.

**Table 3 R45 - 9,000 BTU electrical specifications**

Power Supply Volt — 1-60		Compressor		Indoor Fan Motor		Outdoor Fan Motor		Electric Heat				Unit Electrical Ratings				
Volt	Min	RLA	LRA	FLA	Hp	FLA	Hp	Htr #	Volt	W	HA	TCA	THA	MCA	MOCP	Plug
115V	104	7.5	47	1.4	0.09	1.6	0.125	N/A	N/A	N/A	N/A	10.5	N/A	12.4	15	5-15P
208/ 230V	197	3.9	20	0.6	0.08	0.71	0.09	0	N/A	N/A	N/A	5.2	N/A	6.2	15	6-15P
								2	208	1636	7.9		8.5	10.4	15	6-15P
									230	2000	8.7		9.3	11.5		
								3	208	2454	11.8		12.4	15.3	20	6-20P
									230	3000	13		13.6	16.9		
								4	208	3271	15.7		16.3	20.3	25	6-30P
									230	4000	17.4		18	22.3		
								5	208	4089	19.7		20.3	25.2	30	6-30P
									230	5000	21.7		22.3	27.8		
								265V	240	3.32	18.8		0.67	0.08	0.71	0.09
2	265	2655	10	10.7	13.2	15	7-20P									
3	265	3983	15	15.7	19.5	20										
4	265	5310	20	20.7	25.7	30	7-30P									
5	N/A	N/A	N/A	N/A	N/A	N/A	N/A									

**Table 4 R45 - 12,000 BTU electrical specifications**

Power Supply Volt — 1-60		Compressor		Indoor Fan Motor		Outdoor Fan Motor		Electric Heat				Unit Electrical Ratings				
Volt	Min	RLA	LRA	FLA	Hp	FLA	Hp	Htr #	Volt	W	HA	TCA	THA	MCA	MOCP	Plug
115V	104	10.8	53	1.4	0.09	1.6	0.125	0	N/A	N/A	N/A	13.8	N/A	16.5	25	5-20P
208/ 230V	197	5.6	29	0.6	0.08	0.71	0.09	0	N/A	N/A	N/A	6.9	N/A	8.3	15	6-15P
								2	208	1636	7.9		8.5	10.4	15	6-15P
									230	2000	8.7		9.3	11.5		
								3	208	2454	11.8		12.4	15.3	20	6-20P
									230	3000	13		13.6	16.9		
								4	208	3271	15.7		16.3	20.3	25	6-30P
									230	4000	17.4		18	22.3		
								5	208	4089	19.7		20.3	25.2	30	6-30P
									230	5000	21.7		22.3	27.8		
								265V	240	4.6	20		0.67	0.08	0.71	.09
2	265	2655	10	10.7	13.2											
3	265	3983	15	15.7	19.5	20										
4	265	5310	20	20.7	25.7	30	7-30P									
5	N/A	N/A	N/A	N/A	N/A	N/A	N/A									

## Electrical Specifications

### IMPORTANT

Due to ongoing product development, designs, specifications, and performance are subject to change without notice. Please consult the factory for further information.

**Table 5 R45 - 15,000 Cooling Capacity** electrical specifications

Power Supply Volt — 1-60		Compressor		Indoor Fan Motor		Outdoor Fan Motor		Electric Heat			Unit Electrical Ratings						
Volt	Min	RLA	LRA	FLA	Hp	FLA	Hp	Htr #	Volt	W	HA	TCA	THA	MCA	MOCP	Plug	
208/ 230V	197	7.4	33	0.6	0.08	0.71	0.09	0	N/A	N/A	N/A	8.7	N/A	10.6	15	6-15P	
								2	208	1636	7.9		8.5	10.4	15	6-15P	
									230	2000	8.7		9.3	11.5			
								3	208	2454	11.8		12.4	15.3	20	6-20P	
									230	3000	13		13.6	16.9			
								4	208	3271	15.7		16.3	20.3	25	6-30P	
									230	4000	17.4		18	22.3			
								5	208	4089	19.7		20.3	25.2	30	6-30P	
									230	5000	21.7		22.3	27.8			
								265V	240	6	28		0.67	0.08	0.71	0.09	0
2	265	2655	10	10.7	13.2												
3	265	3983	15	15.7	19.5	20	30					7-30P					
4	265	5310	20	20.7	25.7												
5	N/A	N/A	N/A	N/A	N/A	N/A											N/A

















**Table 6 R45 - 18,000 Cooling Capacity** electrical specifications

Power Supply Volt — 1-60		Compressor		Indoor Fan Motor		Outdoor Fan Motor		Electric Heat			Unit Electrical Ratings					
Volt	Min	RLA	LRA	FLA	Hp	FLA	Hp	Htr #	Volt	W	HA	TCA	THA	MCA	MOCP	Plug
208/ 230V	197	8.3	44	0.6	0.08	0.71	0.09	0	N/A	N/A	N/A	9.6	N/A	11.7	15	6-15P
								2	208	1636	7.9		8.5	10.4	15	6-15P
									230	2000	8.7		9.3	11.5		
								3	208	2454	11.8		12.4	15.3	20	6-20P
									230	3000	13		13.6	16.9		
								4	208	3271	15.7		16.3	20.3	25	6-30P
									230	4000	17.4		18	22.3		
								5	208	4089	19.7		20.3	25.2	30	6-30P
									230	5000	21.7		22.3	27.8		

Note: Consult Factory for 265V Option



## Electrical Specifications

VOLTAGE	125V		250V			265V		
	15(A)	20(A)	15(A)	20(A)	30(A)	15(A)	20(A)	30(A)
PLUG	 5-15 P	 5-20 P	 6-15 P	 6-20 P	 6-30 P	 7-15 P	 7-20 P	 7-30 P
RECEPTACLE	 5-15 R	 5-20 R	 6-15 R	 6-20 R	 6-30 R	 7-15 R	 7-20 R	 7-30 R



ECR International Inc  
2201 Dwyer Avenue  
Utica, NY 13501  
e-mail: [info@RetroAire.com](mailto:info@RetroAire.com)



*An ISO 9001-2008 Certified Company*