

WLCG/WLHG

R-410A High-Efficiency Ductless Split System
High-Wall Air Handlers

EMI *Ductless*

Comfort Where It Counts.

Straight cool / Heat pump nominal capacities			
WLHG09	WLHG12	WLHG24	Units
9,000	12,000	18,000 - 23,800	Btuh
2.6	3.5	5.3 - 7.0	kW
Straight cooling only — nominal capacity			
WLCG30			Units
28,200			Btuh
8.3			kW

Specifications and Performance

(with EMI condensers)



WLCG/WLHG

ECR International LLC
2201 Dwyer Ave
Utica, NY 13504
www.enviromaster.com
e-mail: info@enviromaster.com



An ISO 9001-2000 Certified Company



NOTICE

EMI air handlers and condensers are backed by EMI and ECR International and are tested, rated and certified in accordance with ARI Standard 210/240 and UL-1995. Due to ongoing product development, product designs and specifications may change without notice. Please contact the factory for more information.

P/N 240007993, Rev. C [012210]

WLCG/WLHG Air Handlers — Product Description

Product description

- The WLCG/WLHG is available as a (DX) direct expansion straight cool and heat pump.
- It offers a contemporary design in a ductless type Air Handler and combines attractive appearance with high efficiency conditioning for small to medium size commercial or residential spaces.
- The WLCG/WLHG is equipped with unit mounted infrared compatible controls which also supports 24V remote wall thermostat operation. Optional handheld remote is available.
- Heat pump models provide up to 24,000 Btuh of cooling and 20,600 Btuh of heating. Electric heat options are available for up to 5 kW of supplemental heat.
- This evaporator offers ease of installation, operation, and service.
- It can be matched with EMI's:
 - Single-zone condensing units — S1CG/S1HG 9,000-24,000 Btuh and S1CG 30,000 Btuh.
- All EMI air handlers are backed by Enviromaster International LLC and are tested, rated and certified in accordance with ARI standards 210/240 and UL 1995.



- Motorized supply louver with optional sweep or six stationary settings.
- Modular design – reduces parts required for control package. Deco panel, relay board, ribbon cables and microprocessor are combined into one package.
- Integral condensate pump safety-switch connection where-by the microprocessor monitors the condensate pump safety switch and displays an error code when a fault occurs. (Applies only with field installed condensate pump)
- CEC (California Energy Commission) compliant
- Condensate drain pan over flow protection.
- Staggered Start

Cabinet features:

- Durable ABS plastic cabinet with a galvanized steel sub-chassis.
- Easily accessible, washable, reusable, nylon mesh filter.
- Horizontal discharge louver, constructed of high temperature ABS plastic, that can be set to oscillate, or can be parked in six pre-set positions.
- Manually adjustable vertical discharge fins.
- Easy access to pipe chase area from cabinet bottom allows piping connections and condensate pump installation with the unit mounted on the wall.
- Easily removable end-cap for access to control area for installation and service.
- Condensate drain pan constructed of galvanealed steel with anti-corrosion coating.

Controls and components (Factory-installed or supplied)

- Large LCD Backlit Display
- Single unit-mounted control package, configurable to either unit mount or remote wall thermostat operation, increasing installation flexibility.
- Unit control can be used in cooling only, cooling with electric heat, heat pump, or heat pump with second stage electric heat applications.
- Operational range set point temperature adjustable between 55°F and 90°F (13 to 32°C) in one-degree increments.
- Infrared-compatible controller allows use of optional IR hand held controller. NOTE: Unit-mounted controls are fully functional without the handheld remote.
- Operation modes include Heat, Cool, Dry, Fan and Auto Change-over.
- Fan Operation – Auto/On. High or Low speed fan
- Fan Purge – Fan remains on for 60 seconds after Heat/Cool call is dropped for improved efficiency (Auto mode only)
- Room air sampling — Selectable time intervals ensure the fan will cycle on periodically in Auto Fan Mode to help eliminate room temperature stratification.
- Selectable Fahrenheit (°F) or Celsius (°C) temperature scale.
- Dry mode – Operates cooling and electric heat simultaneously to remove humidity. Optional electric heat must be selected.
- Anti-Short Cycle Compressor Protection.
- Minimum on time for heating and cooling Helps eliminate room temperature drop and system short cycling.
- Freeze Protection – Prevents evaporator freeze up.
- Test operation – Allows ease of testing after installation (all timers are reduced).
- Non-volatile back-up memory will maintain control settings for an indefinite period during a power outage. When power is restored the equipment will resume operation after a three-minute compressor time delay.
- 7 day, 4 event programmable with copy feature.
- Filter change indicator: A timer feature indicates when the filter should be cleaned according to the selected time.

Optional equipment

- Condensate pump (field installed only).
- 24V remote wall thermostat.
- Electric heat with automatic reset high temperature cutout and redundant high temperature fuse link (when heat option is selected) 208/230V only.
- Hand-held infrared controller.

Installer-supplied Items

- Low voltage wiring (Minimum 18 AWG required)
- High voltage power supply wiring
- Mounting screws and fasteners
- Condensate piping
- Refrigerant piping (if not supplied)
- Refrigerant (for interconnect charge)
- Electrical Disconnect High Voltage

Table 1 Discharge air speed and flow @ 230 VAC / Sound values

Model	High speed CFM (l/s)	Low speed CFM (l/s)	Coil	FPM (m/s)	Throw feet (m)	Observed sound values (dBA)
WLHG 09-12	400 (190)	350 (170)	Dry	900 (4.6)	15 (4.6)	45
WLHG24	750 (350)	675 (320)	Dry	1,225 (6.2)	25 (7.5)	56
WLHG30	1,100 (520)	900 (420)	Dry	1,250 (6.4)	27 (8.2)	60

WLCG/WLHG Air Handlers — Product Description *(continued)*

Figure 1 WLCG/WLHG ductless air handlers — dimensions

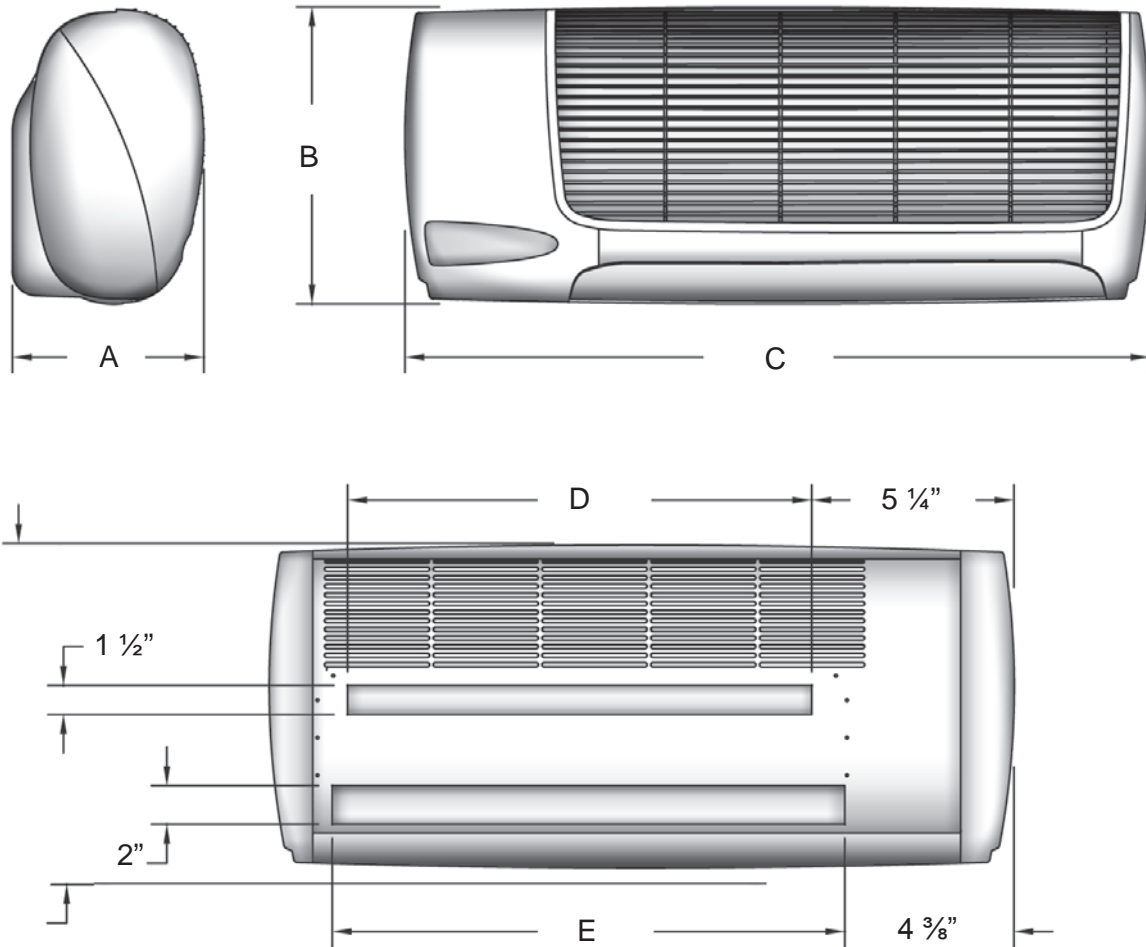

Model	A	B	C	D	E	Shipping weight
	Depth in (mm)	Height in (mm)	Length in (mm)	Mounting bracket clearance in (mm)	Tubing access clearance in (mm)	Pounds (kg)
WLHG09	9 7/8" (251)	15 1/4" (387)	38 1/2" (978)	24" (610)	26 1/2" (673)	58.0 (26.4)
WLHG12	9 7/8" (251)	15 1/4" (387)	38 1/2" (978)	24" (610)	26 1/2" (673)	60.3 (27.4)
WLHG24	9 7/8" (251)	15 1/4" (387)	48 1/2" (1232)	34" (864)	36 1/2" (927)	66.2 (30.0)
WLCG30	9 7/8" (251)	15 1/4" (387)	58 1/2" (1486)	44" (1118)	46 1/2" (1181)	90.1 (40.9)

WLCG/WLHG Air Handlers with S1CG/S1HG/S2CG/S2HG Condensers

S1CG/S1HG/S2CG/S2HG — description

The S1CG/S1HG and S2CG/S2HG condensing units are air-cooled, vertically-arranged side-discharge, high-efficiency units designed specifically to meet or exceed a 13 SEER rating.

- The S1CG Models 9,000-36,000 Btuh and S1HG Models 9,000-24,000 Btuh condensing units will provide cooling and heating for a single evaporator.
- The S2CG/S2HG 18,000 (99), 21,000 (92) and 24,000 (22) Btuh capacity condensing units will provide cooling and heating for two evaporators.
- The S1CG/S1HG, S2CG/S2HG are quiet units that can be recommended for both commercial and residential applications.

NOTICE

When specifying heat pump(s), it is recommended that the matching indoor unit(s) be equipped with electric heat.

Features

- Installation of the S1CG/S1HG and S2CG/S2HG condensing units is simplified by a 24v control interconnection from the evaporator.
- Multiple units can be lined up in close proximity to an exterior wall.
- Service valves are recessed to reduce tampering.
- All 9,000–12,000 Btuh units are equipped with a an oversized suction accumulator with surge baffles and enhanced oil management and a factory-installed solid core filter drier.
- A factory-installed crankcase heater is standard on S1HG 9,000-12,000 Btuh (thermostatically-controlled) and S2HG models, and is available as optional equipment on other models.

**Controls and components
(Factory-installed or supplied)**

- Compressor and fan motor contactor
- Run capacitor
- Low voltage terminal connections
- High pressure switch with manual external reset
- Heat pump hard start
- Cooling operation down to 60° F (15.6° C) standard on all units
- Models 9,000-12,000 Btuh only:
 - Large capacity suction accumulator
 - Solid-core filter drier

Thermostatically-controlled crankcase heater

- This feature energizes the crankcase heater only when needed, saving unnecessary power usage and increasing overall system efficiency.

System options

- Corrosion-resistant coil options (sea coast and harsh environment usage):
 - Copper fin/copper tube condenser coil
 - Coated aluminum fin/copper tube condenser coil
- Low Ambient controls for cooling operation down to 0° F (-18° C)
 - Optional field-installed kits, when specified, for cooling operation down to 0° F — kits include louvers/wind baffle, crankcase heater, and/or fan cycle switch, and installation instructions
- Models S1CG 9,000-12,000 Btuh only:
 - 115v (single-zone only — S1CG or S1HG)
 - Field-installed thermostatically-controlled crankcase heater for heat pump units (S1HG or S2CG)

Installer-supplied items

- Power wiring.
- Low-voltage wiring (18 AWG minimum).
- Secure mounting pad or foundation.
- Refrigerant piping (if not purchased from EMI).
- High-voltage disconnect.
- Refrigerant for charging interconnect piping.

Table 2 Dimensional data, sound data and shipping weights

Model	Size Btu	Unit dimensions Inches (mm)			Sound level dBA	Shipping weight Lbs (kg)
		A	B	C		
S1CG/S1HG9	9,000	24 (610)	15 (381)	36 (914)	59	98 (44.5)
S1CG/S1HG2	12,000	24 (610)	15 (381)	36 (914)	59	98 (44.5)
S1CG/S1HG8	18,000	32 (813)	15 (381)	36 (914)	62	156 (70.9)
S1CG/S1HG4	24,000	32 (813)	15 (381)	40 (1016)	63	156 (70.9)
S1CG3	30,000	38 (965)	15 (381)	44 (1118)	68	210 (95.5)
S2CG	18,000/21,000/24,000	38 (965)	15 (381)	44 (1118)	68	197 (89.6)
S2HG	18,000/21,000/24,000	38 (965)	15 (381)	44 (1118)	68	197 (89.6)
S1CG6	36,000	38 (965)	15 (381)	48 (1219)	68	210 (95.5)

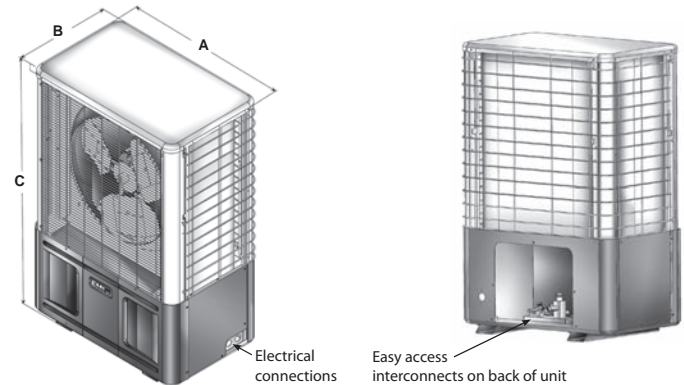
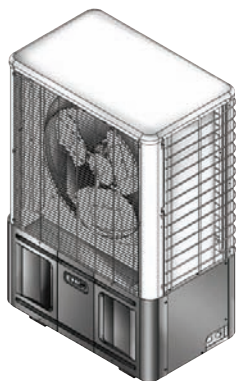

Table 3 Operational Ranges

Unit	Voltage	Accessories Part Numbers (Quantity) Required *** Order ALL Kits Listed Under the Operational Range ***			
		Operational Range			
		32° to 115° F (0 to 46° C)	0° to 115° F (-18 to 46° C)		
		Crankcase Heater Kit	Crankcase Heater Kit	Fan Cycle Switch Kit	Architectural Louver/Hail Guard/Wind Baffle Kit
S1CG9000	115	550002072 (1)	550002072 (1)	550002074 (1)	550001577 (1)
S1CG2000	208/230	550002073 (1)	550002073 (1)	550002074 (1)	550001577 (1)
S1CG8000	208/230	N/R	N/R	550002074 (1)	550001578 (1)
S1CG4000	208/230	N/R	N/R	550002074 (1)	550001602 (1)
S1CG3000	208/230	N/R	N/R	550002074 (1)	550001580 (1)
S2CG	208/230	550002073 (2)	550002073 (2)	550002074 (2)	550001580 (1)
S2HG	208/230	N/R	N/R	550002074 (2)	550001580 (1)
S1CG6000	208/230	N/R	N/R	550002074 (1)	550001581 (1)
S1HG9000	115	N/R	N/R	550002074 (1)	550001577 (1)
S1HG2000	208/230	N/R	N/R	550002074 (1)	550001577 (1)
S1HG8000	208/230	N/R	N/R	550002074 (1)	550001578 (1)
S1HG4000	208/230	N/R	N/R	550002074 (1)	550001602 (1)

Note: N/R - Not Required

WLCG/WLHG Air Handlers with S1CG/S1HG/S2CG/S2HG Condensers (continued)



S1CG/S1HG
Side Discharge



WLCG/WLHG

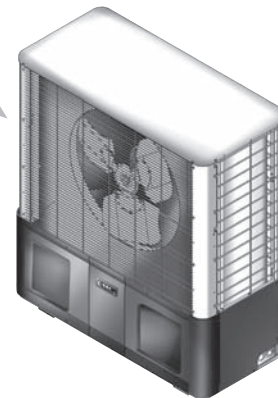

S2CG/S2HG
Side Discharge



Table 4 Performance — cooling system with High Wall units

Condenser	Wall Units	Btuh (Kw)	SEER	SHR	EER	Ref.
S1CG9000	WLHG09	9,000 (2.6)	13.0	0.74	12.2	R-410A
S1CG2000	WLHG12	12,000 (3.5)	13.0	0.68	11.9	R-410A
S1CG8000	WLHG24	18,000 (5.3)	13.0	0.77	12.0	R-410A
S1CG4000	WLHG24	23,800 (7.0)	13.0	0.67	11.4	R-410A
S1CG3000	WLCG30	28,200 (8.3)	13.0	0.79	11.7	R-410A
S2CG2200	WLHG12 + WLHG12	18,000 (5.3)	13.0	0.73	12.1	R-410A
S2CG9200	WLHG09 + WLHG12	21,000 (6.2)	13.0	0.70	12.0	R-410A
S2CG9900	WLHG09 + WLHG09	24,000 (7.0)	13.0	0.68	12.0	R-410A

Table 5 Performance — heat pump system with High Wall units

Condenser	Wall Units	Cooling Btuh (Kw)	Heating Btuh (Kw)	SEER	HSPF	SHR	EER	COP	Ref.
S1HG9000	WLHG09	9,000 (2.6)	8,600 (2.5)	13.0	7.7	0.72	12.8	3.3	R-410A
S1HG2000	WLHG12	12,000 (3.5)	10,600 (3.1)	13.0	7.7	0.69	11.8	3.3	R-410A
S1HG8000	WLHG24	18,000 (5.3)	16,400 (4.8)	13.0	7.7	0.76	11.9	3.5	R-410A
S1HG4000	WLHG24	23,800 (7.0)	20,600 (6.0)	13.0	7.7	0.71	11.9	3.5	R-410A
S2HG2200	UNHG12 + UNHG12	18,000 (5.3)	17,400 (5.1)	13.0	7.7	0.73	12.1	3.2	R-410A
S2HG9200	UNHG09 + UNHG12	21,000 (6.2)	19,200 (5.6)	13.0	7.7	0.70	12.0	3.2	R-410A
S2HG9900	UNHG09 + UNHG09	24,000 (7.0)	21,000 (6.2)	13.0	7.7	0.68	12.0	3.2	R-410A

Table 6 WLCG/WLHG interconnecting line sizes

Capacity	Max. Equivalent Length	Max. Lift	Max. Trap Height	Liquid Line	Suction Line	Condensate Line
		"H"	"P"			
				O.D.	O.D.	I.D.
9,000	50'	20'	15'	1/4"	1/2"	1/2"
	(15 m)	(6 m)	(5 m)	1/4"	1/2"	1/2"
12,000				3/8"	5/8" *	1/2"
18,000	100'	35'	20'	3/8"	3/4"	1/2"
	(30 m)	(11 m)	(6 m)	3/8"	3/4"	1/2"
24,000				3/8"	3/4"	1/2"
30,000				3/8"	3/4"	1/2"

* Must bush down to 5/8" interconnect for 18K system

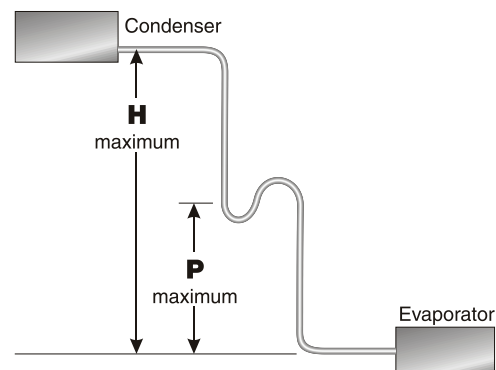

WLCG/WLHG Air Handlers with T2CG, T3CG or T4CG Condensers

T2CG, T3CG or T4CG — description

EMI offers the finest 13 SEER high capacity multi-zone outdoor unit in the ductless split market. These top-discharge high-capacity condensing units allow the installation of up to four circuits from a single outside location when space or aesthetic requirements limit the use of locations. Each zone is independent and no mixing of refrigerant is required.

Features

- Compressors — Hermetically-sealed high-efficiency rotary or reciprocating types, depending on zone loads. Motors are PSC type with inherent overload protection. Compressors are installed on resilient mountings.
- All 9,000 Btuh units are equipped with a Duratec Performance Package that includes an oversized suction accumulator with surge baffles and enhanced oil management and a factory-installed solid core filter drier.
- Cabinet - Fabricated of G90U galvaneal steel, fin-ished with corrosion inhibiting, polyester, powder coated paint (2,000 hr. salt spray tested). Fan Guard — Black vinyl coated. Cabinet Color — Light gray & black.
- Refrigeration Circuit — The T2C, T3C, and T4C are delivered with pre-charged refrigerant (R410A) for the condenser coils and evaporators. Charging of the field-installed piping is required. Unit refrigeration valves are solid brass, for sweat connection. Solid core filter driers are factory installed on all models with rotary compressors.
- Condenser Coil — The condenser coils are tested to 600 psig and are constructed of seamless copper tubing, arranged in staggered configuration, with enhanced aluminum fins. The tubes are mechanically expanded for secure bonding to fin shoulder.
- Condenser Fan/Motor — The condenser fan is a large diameter, high efficiency, three or four blade (depending on capacity) aluminum propeller type, directly connected to the totally enclosed, PSC motor. The motor is fitted with internal thermal protection. These multi-zone units are a draw-through air flow design.

Controls and components
(Factory-installed or supplied)

- Compressor and fan motor contactor
- Run capacitor
- Low voltage terminal connections
- High pressure switch with manual external reset
- Cooling operation down to 60° F (15.6° C) standard on all units
- Models 9,000-12,000 Btuh only:
 - Large capacity suction accumulator
 - Solid-core filter drier

System options

- Corrosion-resistant coil options (sea coast and harsh environment usage):
 - Copper fin/copper tube condenser coil.
 - Coated aluminum fin/copper tube condenser coil.
- Low Ambient controls for cooling operation down to 0° F (standard equipment can operate down to 32°F)
 - Optional field-installed kit, when specified, for cooling operation down to 0°F — kit includes control, louvers and wind baffle plus installation instructions.
 - Low Ambient controls for operation down to 0° F (consult factory for availability)
- Hard-start assist.

Installer-supplied items

- Power wiring.
- Low-voltage wiring (18 awg minimum).
- Secure mounting pad or foundation.
- Refrigerant piping (if not purchased from EMI).
- High-voltage disconnect.
- Refrigerant for charging interconnect piping.

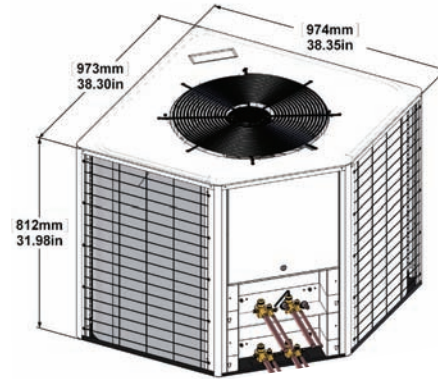

Table 7 Dimensional data, sound data and shipping weights

Model	Size	Sound level dBA	Shipping weight	
			Lbs	kg
T2CG	2400	70	325	147
T2CG	4400	70	325	147
T2CG	8800	70	325	147
T2CG	9800	70	325	147
T3CG	2240	70	325	147
T3CG	9980	70	325	147
T3CG	9990, 2220, 9920	70	325	147
T4CG	2222, 9922, 9992, 9999	70	325	147

Table 8 Operational Ranges

Unit	Size	Accessories Part Numbers (Quantity) Required *** Order ALL Kits Listed Under the Operational Range ***			
		Operational Range			
		32° to 115° F (0 to 46° C)	0° to 115° F (-18 to 46° C)		
		Crankcase Heater Kit	Crankcase Heater Kit	Fan Cycle Switch Kit	Architectural Louver/Hail Guard/Wind Baffle Kit
T2CG	2400, 9800	550002073 (1)	550002073 (1)	550002074 (2)	550002057
T2CG	4400, 8800	N/R	N/R	550002074 (2)	550002057
T3CG	2240, 9980	550002073 (2)	550002073 (2)	550002074 (3)	550002057
T3CG	9990, 2220, 9920	550002073 (3)	550002073 (3)	550002074 (3)	550002057
T4CG	2222, 9922, 9992, 9999	550002073 (4)	550002073 (4)	550002074 (4)	550002057

Note: N/R - Not Required

WLCG/WLHG

R-410A High-Efficiency Ductless Split System
High-Wall Air Handlers

EMI  *Ductless*

Comfort Where It Counts.

Straight cool / Heat pump nominal capacities			
WLHG09	WLHG12	WLHG24	Units
9,000	12,000	18,000-23,800	Btuh
2.6	3.5	5.3-7.0	kW
Straight cooling only – nominal capacity			
WLCG30			Units
28,200			Btuh
8.3			kW

Engineering Submittal

Job Name:

Location:

Customer:

Project Engineer:

Project Architect:

General Contractor:

Submitted by:

For: Reference [] Approval []

Date:

ECR International LLC
2201 Dwyer Ave
Utica, NY 13504
www.enviromaster.com
e-mail: info@enviromaster.com



An ISO 9001-2000 Certified Company



NOTICE

EMI air handlers and condensers are backed by EMI and ECR International and are tested, rated and certified in accordance with ARI Standard 210/240 and UL-1995. Due to ongoing product development, product designs and specifications may change without notice. Please contact the factory for more information.

Please fill in the boxes below to specify the air handler units

Selection 1

Quantity required:

Type [**WL** = wall-mounted air handler]

Operation [**C** = cooling—DX]
[**H** = heat pump (WL09–24 only)]

Revision [**G** = R-410A refrigerant]

Capacity [**09** = 9,000 Btuh]
[**12** = 12,000 Btuh]
[**24** = 18 / 24,000 Btuh]
[**30** = 30,000 Btuh (cooling only)]
[**36** = 36,000 Btuh (cooling only)]

Auxiliary heat:
[**0** = no auxiliary heat]
[**3** = 3 kw @ 208/230 VAC (09, 12, 24 only)]
[**5** = 5 kw @ 208/230 VAC (09, 12, 24 only)]

Voltage [**A** = 115 VAC (09–12 only)]
[**D** = 208/230 VAC]

EXAMPLES

W L C G 3 0 D 5

Cooling application | 36,000 Btuh capacity
| 208/230 VAC | 5 kw auxiliary heat

W L H G 2 4 D 5

Heat pump application | 18 / 24,000 Btuh capacity
| 208/230 VAC | 5 kw auxiliary heat

Please check the boxes below to specify optional field-installed accessories

<input type="checkbox"/>	Condensate Pump	<input type="checkbox"/>	Refrigerant line set, 10-feet
<input type="checkbox"/>	Remote thermostat for air handler	<input type="checkbox"/>	Refrigerant line set, 25-feet
<input type="checkbox"/>	Handheld IR remote controller	<input type="checkbox"/>	Refrigerant line set, 50-feet
<input type="checkbox"/>	Wind baffle / hail guard, architectural louver kit (required for cooling operation to 0°F (-18°C))		
<input type="checkbox"/>	Crankcase Heater (S1CG 9,000 - 12,000 Btuh only) required for cooling operating below 60°F (15°C)		
<input type="checkbox"/>	Hard Start Kit		
<input type="checkbox"/>	Fan Cycle Switch (required for cooling operation below 32°F (0°C))		

Please fill in the boxes below to specify the condenser unit

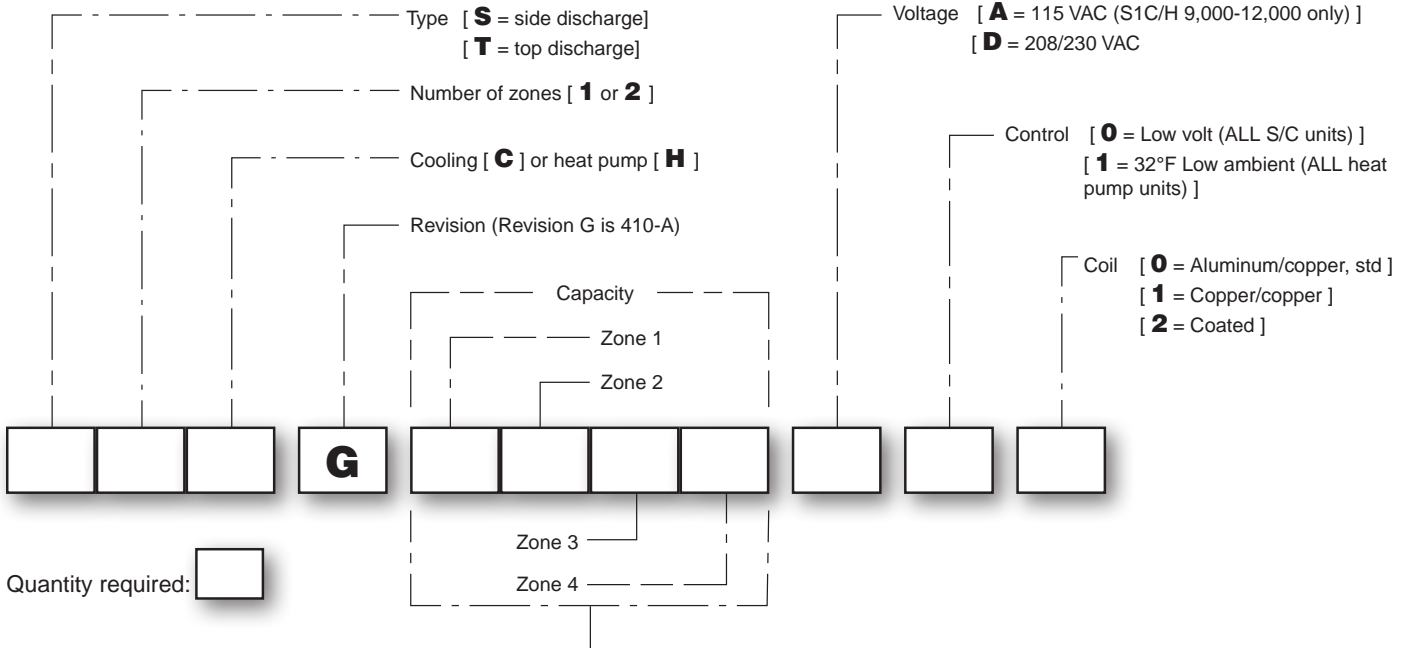

Capacity code	
Individual zone capacity	
Code	Capacity Btuh
0	Empty zone
9	9,000
2	12,000
8	18,000
4	24,000
3	30,000 *
6	36,000 *

* Straight cooling units ONLY

Max total capacity	
Multi-zone units	
(S) 2 zones	24,000 Btuh max total
(T) 4 zones	48,000 Btuh max total

Available Units					
(S)	Description	(T)	Description		
Capacity codes	(Max combined capacity = 24,000 Btuh)	Capacity code	(Maximum combined capacity = 48,000 Btuh)		
9000	One zone 9,000 Btuh	2400	Two zones 12,000 / 24,000 Btuh		
2000	One zone 12,000 Btuh	4400	Two zones 24,000 / 24,000 Btuh		
8000	One zone 18,000 Btuh	8800	Two zones 18,000 / 18,000 Btuh		
4000	One zone 24,000 Btuh	9800	Two zones 9,000 / 18,000 Btuh		
3000 *	One zone 30,000 Btuh	2220	Three zones 12,000 / 12,000 / 12,000 Btuh		
6000 *	One zone 36,000 Btuh	2240	Three zones 12,000 / 12,000 / 24,000 Btuh		
9900	Two zones 9,000 / 9,000 Btuh	9920	Three zones 9,000 / 9,000 / 12,000 Btuh		
9200	Two zones 9,000 / 12,000 Btuh	9980	Three zones 9,000 / 9,000 / 18,000 Btuh		
2200	Two zones 12,000 / 12,000 Btuh	9990	Three zones 9,000 / 9,000 / 9,000 Btuh		
* Available in straight cooling units ONLY				9999 Four zones 9,000 / 9,000 / 9,000 / 9,000 Btuh	
				9992 Four zones 9,000 / 9,000 / 9,000 / 12,000 Btuh	
				9922 Four zones 9,000 / 9,000 / 12,000 / 12,000 Btuh	
				2222 Four zones 12,000 / 12,000 / 12,000 / 12,000 Btuh	

EXAMPLES

S 1 C G 8 0 0 0 D 0 1

Side discharge | one zone | cooling only | rev. G | 18,000 Btuh | 208/230 V | 32°F Low ambient control | copper fin, copper tube coil

T 2 H G 9 8 0 0 D 1 2

Top discharge | two zones | heat pump | rev. G | 9,000 / 18,000 Btuh | 208/230 V | 32°F Low ambient control | coated coil

S 2 H G 9 2 0 0 D 1 0

Side discharge | two zones | heat pump | rev. G | 9,000 / 12,000 Btuh | 208/230 V | standard low volt control | aluminum fin, copper tube coil

T 4 C G 9 9 2 2 D 0 2

Top discharge | four zones | cooling only | rev. G | 9,000 / 9,000 / 12,000 / 12,000 Btuh | 208/230 V | standard low volt control | coated coil

EMI's Product Line

Indoor Units

WLCG/WLHG
High Wall Air Handler



CACG/CAHG
Cassette Air Handler



UNCG/UNHG
Universal Floor or Ceiling Air Handler

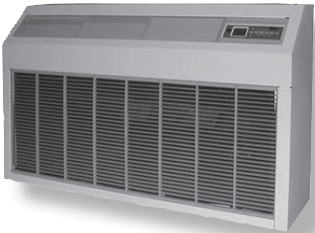

Outdoor Units

S2CG Dual Zone
Side Discharge

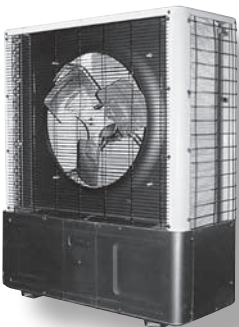

S1CG & S1HG
Single Zone
Side Discharge

**T2CG/T2HG, T3CG/
T3HG and
T4CG/T4HG 2, 3 and
4 Zone**
Top Discharge



ECR International LLC
2201 Dwyer Ave
Utica, NY 13504
www.enviromaster.com
e-mail: info@enviromaster.com



An ISO 9001-2000 Certified Company

WLCG/WLHG Air Handlers with T2CG, T3CG or T4CG Condensers (continued)

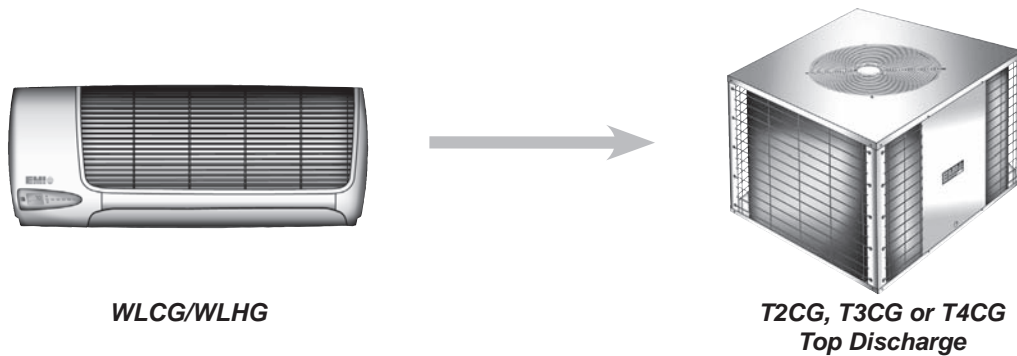

Table 9 System options with T2C, T3C or T4C top discharge

Condenser	Wall Units	Btuh	SEER	SHR	EER	Ref.
T2CG8800	(2) WLHG24	36,000	13	0.79	12.1	R410A
T2CG4400	(2) WLHG24	47,500	13	0.73	11.8	R410A
T2CG9800	(1) WLHG09+ (1) WLHG24	27,000	13	0.8	12	R410A
T2CG2400	(1) WLHG12+ (1) WLHG24	35,800	13	0.72	12	R410A
T3CG9990	(3) WLHG09	27,000	13	0.8	11.7	R410A
T3CG2220	(3) WLHG12	36,000	13	0.71	11.7	R410A
T3CG9920	(2) WLHG09+(1) WLHG12	30,000	13	0.77	11.9	R410A
T3CG9980	(2) WLHG09+(1) WLHG24	36,000	13	0.8	12	R410A
T3CG2240	(2) WLHG12+(1) WLHG24	46,000	13	0.72	12	R410A
T4CG9999	(4) WLHG09	36,000	13	0.8	11.8	R410A
T4CG2222	(4) WLHG12	48,000	13	0.73	11.7	R410A
T4CG9992	(3) WLHG09+(1) WLHG12	39,000	13	0.71	11.8	R410A
T4CG9922	(2) WLHG09+(2) WLHG12	42,000	13	0.73	11.9	R410A

Table 10 WLCG/WLHG interconnecting line sizes

Model/ Zone	Max. Length	Max. Lift	Max. Trap Height	Liquid Line	Suction Line	Condensate Line	Model/ Zone	Max. Length	Max. Lift	Max. Trap Height	Liquid Line	Suction Line	Condensate Line
				O.D.	O.D.	I.D.					O.D.	O.D.	I.D.
09	50' (15 m)	20' (6 m)	15' (5 m)	1/4"	1/2"	1/2"	18	100' (30 m)	35' (11 m)	20' (6 m)	3/8"	5/8"	1/2"
				1/4"	1/2"	1/2"					3/8"	3/4"	1/2"
12							30				3/8"	3/4"	1/2"
											36		

WLCG/WLHG Air Handlers with T2HG, T3HG or T4HG Condensers

T2HG, T3HG or T4HG — description

EMI offers the finest multi-zone heat pump outdoor units in the ductless split market, the T series (T2HB, T3HB & T4HB) condensing units. These units allow the installation of two or more circuits from a single outside location, ideal for when space or aesthetic requirements limit the use of the number of cabinets outdoors. Each zone is independent so no mixing of refrigerant occurs.

NOTICE

When specifying heat pump(s), it is recommended that the matching indoor unit(s) be equipped with electric heat.

Features

- Compressors — Hermetically-sealed high-efficiency rotary or reciprocating types, depending on zone loads. Motors are PSC type with inherent overload protection. Compressors are installed on resilient mountings.
- All 9,000-12,000 Btuh units are equipped with a Duratec Performance Package that includes an oversized suction accumulator with surge baffles and enhanced oil management and a factory-installed solid core filter drier.
- Cabinet - Fabricated of G90U galvaneal steel, finished with corrosion inhibiting, polyester, powder coated paint (2,000 hr. salt spray tested). Fan Guard — Black vinyl coated. Cabinet Color — Light gray & black.
- Refrigeration Circuit — The T2C, T3C, and T4C are delivered with pre-charged refrigerant (R410A) for the condenser coils and evaporators. Charging of the field-installed piping is required. Unit refrigeration valves are solid brass, for sweat connection. Solid core filter driers are factory installed on all models with rotary compressors.
- Condenser Coil — The condenser coils are tested to 600 psig and are constructed of seamless copper tubing, arranged in staggered configuration, with enhanced aluminum fins. The tubes are mechanically expanded for secure bonding to fin shoulder.
- Condenser Fan/Motor — The condenser fan is a large diameter, high efficiency, three or four blade (depending on capacity) aluminum propeller type, directly connected to the totally enclosed, PSC motor. The motor is fitted with internal thermal protection. These multi-zone units are a draw-through air flow design.
- All 18,000 and 24,000 Btuh circuit units include a solid core filter drier and high pressure limit switch. The 18,000 Btuh circuits also include a large capacity suction accumulator with surge baffles and enhanced oil management.

Controls and components (factory installed and supplied)

- Compressor and fan motor contactor
- Run capacitor
- Low voltage terminal connections
- High pressure switch with manual external reset
- Heat pump hard start
- Cooling operation down to 60° F (15.6° C) standard on all units
- Models 9,000-12,000 Btuh only:
 - Large capacity suction accumulator
 - Solid-core filter drier

Thermostatically-controlled crankcase heater

- This feature energizes the crankcase heater only when needed, saving unnecessary power usage and increasing overall system efficiency.

System options

- Corrosion-resistant coil options (sea coast and harsh environment usage):
 - Copper fin/copper tube condenser coil.
 - Coated aluminum fin/copper tube condenser coil.
- Wind baffles — louvers.

Installer-supplied items

- Power wiring.
- Low-voltage wiring (18 awg minimum).
- Secure mounting pad or foundation.
- Refrigerant piping (if not purchased from EMI).
- High-voltage disconnect.
- Refrigerant for charging interconnect piping.

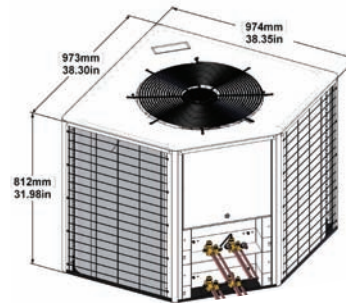

Table 11 Dimensional data, sound data and shipping weights

Model	Size	Sound level dBA	Shipping weight	
			Lbs	kg
T2HG	2400	70	325	147
T2HG	4400	70	325	147
T2HG	8800	70	325	147
T2HG	9800	70	325	147
T3HG	2240	70	325	147
T3HG	9980	70	325	147
T3HG	9990, 2220, 9920	70	325	147
T4HG	2222, 9922, 9992, 9999	70	325	147

Table 12 Operational Ranges

Unit	Size	Accessories Part Numbers (Quantity) Required *** Order ALL Kits Listed Under the Operational Range ***			
		Operational Range			
		32° to 115° F (0 to 46° C)	0° to 115° F (-18 to 46° C)		Architectural Louver/Hail Guard/Wind Baffle Kit
Crankcase Heater Kit	Crankcase Heater Kit	Fan Cycle Switch Kit			
T2HG	2400, 9800	N/R	N/R	N/R	550002057
T2HG	4400, 8800	N/R	N/R	N/R	550002057
T3HG	2240, 9980	N/R	N/R	N/R	550002057
T3HG	9990, 2220, 9920	N/R	N/R	N/R	550002057
T4CG	2222, 9922, 9992, 9999	N/R	N/R	N/R	550002057

Note: N/R - Not Required

WLCG/WLHG Air Handlers with T2HG, T3HG or T4HG Condensers (continued)

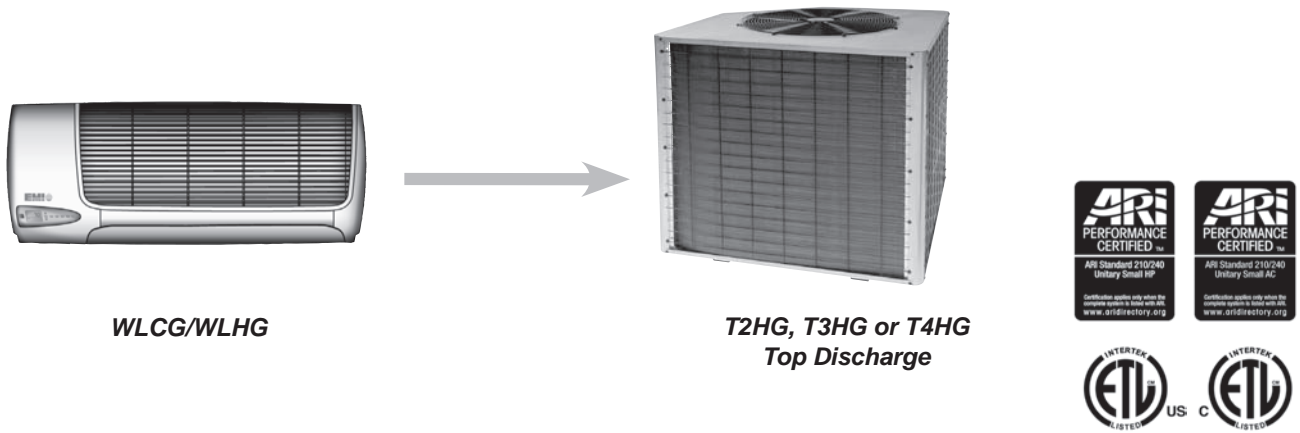

WLCG/WLHG

**T2HG, T3HG or T4HG
Top Discharge**



Table 13 System options with T2H, T3H or T4H top discharge

Condenser	Air Handlers	Cooling Btuh	Heating Btuh	SEER	HSPF	SHR	EER	COP	Ref.
T2HG8800	(2) WLHG24	36,000	34,000	13.0	7.7	0.79	12.1	3.3	R410A
T2HG4400	(2) WLHG24	47,500	41,000	13.0	7.7	0.73	11.8	3.2	R410A
T2HG9800	(1) WLHG09+ (1) WLHG24	27,000	25,600	13.0	7.7	0.8	12	3.3	R410A
T2HG2400	(1) WLHG12+ (1) WLHG24	36,000	31,500	13.0	7.7	0.72	12	3.3	R410A
T3HG9990	(3) WLHG09	27,000	25,800	13.0	7.7	0.8	11.7	3.2	R410A
T3HG2220	(3) WLHG12	36,000	33,000	13.0	7.7	0.71	11.7	3.2	R410A
T3HG9920	(2) WLHG09+(1) WLHG12	30,000	28,200	13.0	7.7	0.77	11.9	3.2	R410A
T3HG9980	(2) WLHG09+(1) WLHG24	36,000	34,200	13.0	7.7	0.8	12	3.2	R410A
T3HG2240	(2) WLHG12+(1) WLHG24	46,000	42,500	13.0	7.7	0.72	12	3.3	R410A
T4HG9999	(4) WLHG09	36,000	34,400	13.0	7.7	0.8	11.8	3.2	R410A
T4HG2222	(4) WLHG12	48,000	49,000	13.0	7.7	0.73	11.7	3.2	R410A
T4HG9922	(2) WLHG09+(2) WLHG12	42,000	39,200	13.0	7.7	0.73	11.9	3.3	R410A

Table 14 WLCG/WLHG interconnecting line sizes

Model/ Zone	Max. Length	Max. Lift	Max. Trap Height	Liquid Line	Suction Line	Condensate Line	Model/ Zone	Max. Length	Max. Lift	Max. Trap Height	Liquid Line	Suction Line	Condensate Line
				O.D.	O.D.	I.D.					O.D.	O.D.	I.D.
09	50' (15 m)	20' (6 m)	15' (5 m)	1/4"	1/2"	1/2"	18	100' (30 m)	35' (11 m)	20' (6 m)	3/8"	5/8"	1/2"
				1/4"	1/2"	1/2"					24	3/8"	3/4"
12	(15 m)	(6 m)	(5 m)	1/4"	1/2"	1/2"	30	(30 m)	(11 m)	(6 m)	3/8"	3/4"	1/2"
				1/4"	1/2"	1/2"					36	3/8"	3/4"

Electrical Specifications

NOTICE

Due to ongoing product development, designs, specifications, and performance are subject to change without notice. Please consult the factory for further information.

Table 15 Electrical specifications — WLCG/WLHG

MODEL	VOLTS/HZ/PH	FAN RLA	HP	HEATER K.W.	AMPS	TOTAL AMPS	MIN VOLT	M.C.A.	HACR BRKR
WLHG 09-12	115/60/1	0.64	0.02	–	–	0.64	104	0.8	15
	208/230/60/1	0.34	0.02	–	–	0.34	197	0.4	15
	208/230/60/1	0.34	0.02	3	13.04	13.38	197	16.7	20
WLHG 24	208/230/60/1	0.56	0.07	–	–	0.56	197	0.7	15
	208/230/60/1	0.56	0.07	3	13.04	13.6	197	17	20
	208/230/60/1	0.56	0.07	5	21.74	22.3	197	27.9	30
WLCG 30	208/230/60/1	0.8	0.10	–	–	0.8	197	1	15
	208/230/60/1	0.8	0.10	5	21.74	22.54	197	28.2	30

Table 16 Electrical specifications — S1CG/S1HG,S2CG/S2HG

Model #	Volts/HZ/PH	Fan Motor		Compressor				Total amps	Min volt	M.C.A.	HACR BRKR
		AMPS	HP	Circuit 1		Circuit 2					
				RLA	LRA	RLA	LRA				
S1CG9000A S1HG9000A	115/60/1	1.4	0.125	7.5	47	N/A		8.9	104	10.8	15
S1CG2000A S1HG2000A	115/60/1	1.4	0.125	9.9	53	N/A		11.3	104	13.8	20
S1CG9000D S1HG9000D	208/230/60/1	0.8	0.125	3.9	20	N/A		4.7	197	5.7	15
S1CG2000D S1HG2000D	208/230/60/1	0.8	0.125	5.2	27	N/A		6.0	197	7.3	15
S1CG8000D S1HG8000D	208/230/60/1	0.8	0.125	5.9	43	N/A		6.7	197	8.2	15
S1CG4000D S1HG4000D	208/230/60/1	0.8	0.125	8.0	43	N/A		8.8	197	10.8	15
S1CG3000D	208/230/60/1	1.8	0.330	11.6	74	N/A		13.4	197	16.3	25
S1CG6000D	208/230/60/1	1.8	0.330	12.7	74	N/A		14.5	197	17.7	30
S2CG2200D S2HG2200D	208/230/60/1	1.8	0.330	5.2	27	5.2	27	9.6	197	10.6	15
S2CG9200D S2HG9200D	208/230/60/1	1.8	0.330	3.9	20	5.2	27	10.9	197	12.2	15
S2CG9900D S2HG9900D	208/230/60/1	1.8	0.330	3.9	20	3.9	20	12.2	197	13.5	15

M.C.A. - minimum circuit amps

Electrical Specifications (cont.)

Table 17 Electrical specifications — T2CG/T3CG/T4CG, T2HG/T3HG/T4HG

Model #	Volts/HZ/PH	Fan Motor		Compressor Zone-1		Compressor Zone-2		Compressor Zone-3		Compressor Zone-4		Total amps	Min volt	M.C.A.	HACR BRKR
		AMPS	HP	RLA	LRA	RLA	LRA	RLA	LRA	RLA	LRA				
T2CG2400D	208/230/60/1	1.8	0.33	5.2	27	8.2	58.3					15.2		17.3	25
T2CG4400D	208/230/60/1	1.8	0.33	8.2	58.3	8.2	58.3					18.2	197	20.3	25
T2CG8800D	208/230/60/1	1.8	0.33	5.9	43	5.9	43					13.6	197	15.1	20
T2CG9800D	208/230/60/1	1.8	0.33	3.9	20	5.9	43					11.6	197	13.1	15
T3CG2220D	208/230/60/1	1.8	0.33	5.2	27	5.2	27	5.2	27			17.4	197	18.7	20
T3CG2240D	208/230/60/1	1.8	0.33	5.2	27	5.2	27	8.2	58.3			20.4	197	22.5	30
T3CG9920D	208/230/60/1	1.8	0.33	3.9	20	3.9	20	5.2	27			14.8	197	16.1	20
T3CG9990D	208/230/60/1	1.8	0.33	3.9	20	3.9	20	3.9	20			13.5	197	14.5	15
T3CG9980D	208/230/60/1	1.8	0.33	3.9	20	3.9	20	5.9	43			15.5	197	17	20
T4CG2222D	208/230/60/1	1.8	0.33	5.2	27	5.2	27	5.2	27	5.2	27	22.6	197	23.9	25
T4CG9922D	208/230/60/1	1.8	0.33	3.9	20	3.9	20	5.2	27	5.2	27	20	197	21.3	25
T4CG9992D	208/230/60/1	1.8	0.33	3.9	20	3.9	20	3.9	20	5.2	27	18.7	197	20	25
T4CG9999D	208/230/60/1	1.8	0.33	3.9	20	3.9	20	3.9	20	3.9	20	17.4	197	18.4	20
T2HG2400D	208/230/60/1	1.8	0.33	5.2	27	8.2	58.3					15.2	197	17.3	25
T2HG4400D	208/230/60/1	1.8	0.33	8.2	58.3	8.2	58.3					18.2	197	20.3	25
T2HG8800D	208/230/60/1	1.8	0.33	5.9	43	5.9	43					13.6	197	15.1	20
T2HG9800D	208/230/60/1	1.8	0.33	3.9	20	5.9	43					11.6	197	13.1	15
T3HG2220D	208/230/60/1	1.8	0.33	5.2	27	5.2	27	5.2	27			17.4	197	18.7	20
T3HG2240D	208/230/60/1	1.8	0.33	5.2	27	5.2	27	8.2	58.3			20.4	197	22.5	30
T3HG9920D	208/230/60/1	1.8	0.33	3.9	20	3.9	20	5.2	27			14.8	197	16.1	20
T3HG9980D	208/230/60/1	1.8	0.33	3.9	20	3.9	20	5.9	43			15.5	197	17	20
T3HG9990D	208/230/60/1	1.8	0.33	3.9	20	3.9	20	3.9	20			13.5	197	14.5	15
T4HG2222D	208/230/60/1	1.8	0.33	5.2	27	5.2	27	5.2	27	5.2	27	22.6	197	23.9	25
T4HG9922D	208/230/60/1	1.8	0.33	3.9	20	3.9	20	5.2	27	5.2	27	20	197	21.3	25
T4HG9992D	208/230/60/1	1.8	0.33	3.9	20	3.9	20	3.9	20	5.2	27	18.7	197	20	25
T4HG9999D	208/230/60/1	1.8	0.33	3.9	20	3.9	20	3.9	20	3.9	20	17.4	197	18.4	20

M.C.A. - minimum circuit amps

EMI's Product Line

Indoor Units

WLCG/WLHG
High Wall Air Handler



CACG/CAHG
Cassette Air Handler



UNCG/UNHG
Universal Floor or Ceiling Air Handler

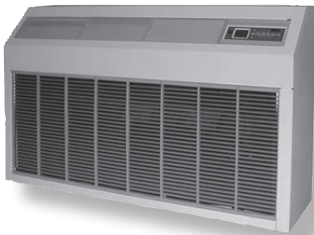

Outdoor Units

S2CG/S2HG Dual Zone
Side Discharge

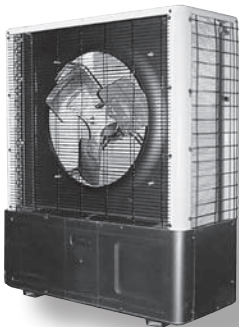

S1CG/S1HG
Single Zone
Side Discharge

**T2CG/T2HG, T3CG/
T3HG and
T4CG/T4HG 2, 3 and
4 Zone**
Top Discharge



ECR International LLC
2201 Dwyer Ave
Utica, NY 13504
www.enviromaster.com
e-mail: info@enviromaster.com